

## FCZI

### Fan coils with Inverter Brushless motor (EC) Universal and floor installation

- Electric saving equal to 50% compared to a fan coil with 3-speed motor
- Advanced controller allowing programming via smart devices
- Dualjet version for highest four-season comfort



EUROVENT LCP

Drawing from its wide experience in the field of fan coils, Aermec presents the new FCZI series: the elegant design goes hand in hand with low noise and important energy savings.

Inverter motor allows precise adaptation to the real indoor environment requirements without temperature oscillations.

The air flow can be continuously changed through a 1-10 V signal, coming from adjustment and control commands Aermec or from independent adjustment systems. This lowers noise and generates a better response to heat loads and a higher stability in the desired temperature inside the room. The high efficiency even with low speed, makes it possible to reduce power consumption (more than 50% less than fan coils with traditional motors). In term of noise, in any operating condition exceptional values have been observed.

FCZI can be installed in any 2/4 pipe system and operates with any heat generator even at low temperatures, and thanks to varied versions and settings, it is easy to pick the ideal solution for any need.

#### Versions without installed controller

Vertical or horizontal installation:

FCZI\_U  
FCZ\_UF

Vertical installation:

FCZI\_AS  
FCZ\_AF

#### With installed controller

Vertical installation:

FCZI\_DT  
FCZI\_D  
FCZI\_ACT

- Housing RAL9003, grille/feet RAL 7047
- Brushless motor with 0-100% speed continuous variation to guarantee best performance at very low sound level
- Centrifugal fan designed to guarantee continuous modulation of the air flow rate and to increase comfort and electric saving.
- Metallic protective cabinet with rustproofing polyester paint
- Adjustable air distribution grille (U version)
- Automatic power-off function with closure of the air delivery grille, (U version)
- Low loss of charge in the heat exchanger
- Easy installation and maintenance
- G2 air filter for all versions.
- Extractable shrouds for easy, effective cleaning
- The hydraulic connections can be inverted during installation (only valid for units with a single coil, those with a supplementary coil cannot be inverted).

The ThermApp application (applicable with T-TOUCH controller) operates by simply placing a smart device on the fan coil. The App allows working mode and time schedule programming, sleep mode activation, alarm listing, etc. ThermApp is available for Android Operating Systems.

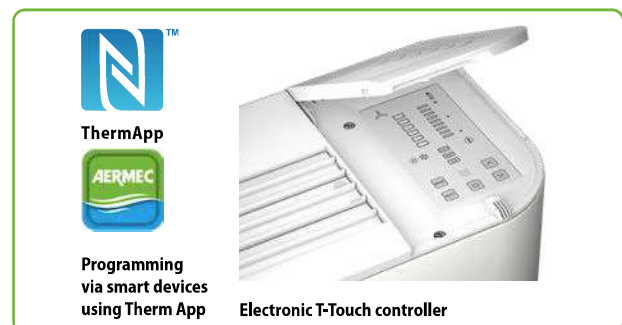

## CONFIGURATIONS AVAILABLE

### With fixed grille (vertical free-standing) - A

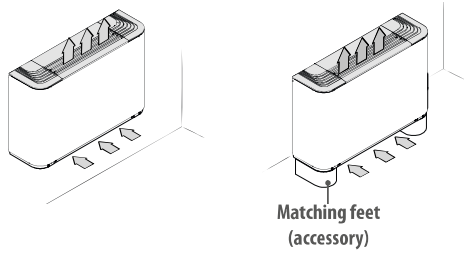

#### FCZI\_AS

- Without installed controller
- Compatible with VMF system

#### FCZI\_ACT

- With electronic controller (for 2 pipe systems)

#### Vertical installation only

- For 2/4 pipe systems

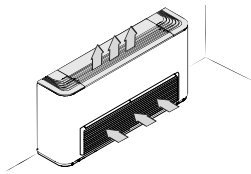

#### FCZI\_AF

- Without installed controller
- Compatible with VMF system
- Front intake louver

### With double flow (Dualjet) - D

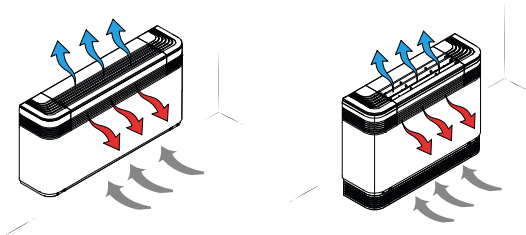

**Dualjet, unique to Aermec, offers notably improved seasonal comfort by directing the air flow according to the season. In winter warm air is directed towards the floor; in summer cool air is directed towards the ceiling.**

**FCZI\_D** With installed controller

**FCZI\_DT** With installed controller T-Touch

FCZ\_D units are compatible with the the VMF system, in this case you will need to contact the headquarter

- You can change the air supply orientation, frontal or from above, by acting directly on the adjustable grid.

#### Only vertical installation

- For 2 pipe system (4 pipe system with VCF\_X4 , VMF system or FCZI\_DT)

### With adjustable/fixed grille (Universal) - U

#### With adjustable air distribution grille - U

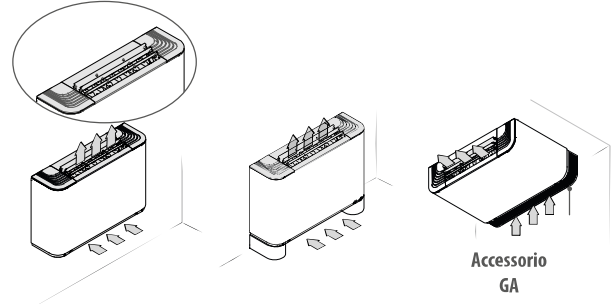

#### FCZI\_U

- Without installed controller
- Compatible with VMF system
- Adjustable air distribution grille
  - Single for size 2-3
  - Three independent for sizes 4-5-7-9

**With the flap completely closed the unit is off**

#### Vertical or horizontal installation

- For 2/4 pipe systems

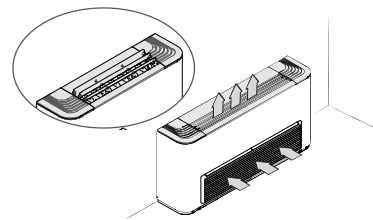

#### FCZI\_UF

- Without installed controller
- Compatible with VMF system
- Adjustable grille front intake louver

## CONFIGURATOR

Field	Description
1,2,3,4	FCZI
5	Size
	2-3-4-5-7-9
6	Main coil
0	Standard
5	Oversized (1)
7	Supplementary coil
0	Without coil
1	Standard
2	Oversized

(1) Oversized coil "5" does not allow the installation of the supplementary coil "1 or 2"

Field	Description
8,9	Versions
D	Dualjet with installed controller
DT	With installed controller T-Touch
AS	Free standing without installed switch
AF	Free standing without switch Front intake louver
ACT	Free standing with electronic controller
U	Universal with adjustable grille, without installed controller
UF	Universal with adjustable grille, without installed controller front intake louver

## SIZE AVAILABLE FOR VERSION

Versions	Size available main coil only (2 pipes)											
FCZI	200	250	300	350	400	450	500	550	700	750	900	950
AS	*	*	*	*	*	*	*	*	*	*	*	*
AF	*	*	*	*	*	*	*	*	/	/	*	*
ACT	*	*	*	*	*	*	*	*	*	*	*	*
U	*	*	*	*	*	*	*	*	*	*	*	*
UF	*	*	*	*	*	*	*	*	/	/	*	*
D	*	/	*	/	*	/	*	/	/	/	/	/
DT	*	/	*	/	*	/	*	/	/	/	/	/

Versions	Size available main and supplementary coil (4 pipes)										
FCZI	201	202	301	302	401	402	501	502	701	702	901
AS	*	*	*	*	*	*	*	*	*	*	*
ACT	*	*	*	*	*	*	*	*	*	*	*
U	*	*	*	*	*	*	*	*	*	*	*
D	/	/	/	/	/	/	/	/	/	/	/
DT	/	/	/	/	/	/	/	/	/	/	/

## ACCESSORIES

### Control panel

**T-TOUCH-I:** Touch controller mounted on-board. allows remote control with (Android) smart devices using the ThermApp application.

**A range of dedicated controls, wall-mounted or on the machine, is available but it is essential to choose between these panels for simple and complete tuning, for more details please refer to the dedicated sheet.**

### Probes and accessories for control panels

**WMT21:** Electronic thermostat with LCD display (wall installation).

**SWAI:** Water temperature probe for WMT21 control panels. Cable length L=2m.

**PTI2Z:** Electronic thermostat on board the fan coil

### VMF system

**VMF-E2Z:** User interface for mounting on with two selectors: one to control the temperature and one for the speed

**VMF-E4X:** Wall mounted user interface allowing control via a capacitive touch keyboard.

**VMF-E19I:** Thermostat for inverter unit to be fixed on the side of the fan coil, fitted as standard with an air and water probe.

**VMF-IO:** Expansion board that expands the availability of Digital Inputs and Outputs.

**VMF-LON:** Expansion that allows interfacing with a thermostat with BMS systems using the LON protocol.

**VMF-SW:** water sensor replacing that supplied with VMF-E19 thermostats for installation upstream of the valve.

**VMF-SW1:** additional water sensor for 4-pipe systems with E1 thermostats offering maximum control in the cooling range.

### Coil - Hot water

**BV:** Single row hot water heat exchanger. Not available for sizes with Oversized main coil.

### Valve Kit

**VCZ\_X4:** Valve kits for single coil units, installed in 4 pipe systems with totally separated "Cooling" and "Heating" circuits. The kit consists of 2 valves with 3-way 4 port connection complete with electro-thermal actuators, insulating shells for the valves and associated hydraulic piping. Version\_X4L valve kit allows left side connection. Version\_X4R valve kit allows right side connection. Power supply 230V ~ 50Hz

**VCZ or VCF: kit containing a motorised 3-way valve** with insulating shell plus coupling and pipes in insulated copper. Applicable for standard or oversized main coil. Available with 230V and 24V~50Hz power supply.

**VCZD or VCFD: Kit consisting of powered 2-way valve,** copper couplings and pipes applicable for standard or oversized main coil. Available with 230V and 24V~50Hz power supply.

**VJP/VJP\_M: Control and balancing combination valve for 2 and 4 pipe systems to install outside the unit, supplied without fittings and hydraulic components.** The valve, which can guarantee a constant water flow rate in the terminal, within its operating range, is available with 230V and 24V~50Hz power supply.

**The VJP is controlled by on-off logic** with compatible control panels (accessories)

**The VJP\_M is controlled by modulating logic** with panels not supplied by Aermec

**The design water flow rate is crucial to refine the selection of the valve shown in the compatibility table.**

### Installation accessoires

**AMP:** kit for the wall mounting installation.

**BCZ:** Auxiliary condensate drip tray

**GA:** Grille to hide hydraulics and electrics on ceiling mounted units; also applicable for floor installation.

**ZXZ:** Copy of esthetical and structural feet

■ Refer to dedicated product Leaflet for further details concerning control panel and VMF System

## ACCESSORIES COMPATIBILITY

FCZI		Single coil model											
		200	250	300	350	400	450	500	550	700	750	900	950
<b>Probes and accessories for control panels</b>													
AER503	AS-AF-UJ-UF	*	*	*	*	*	*	*	*	*	*	*	*
SW5	AS-AF-UJ-UF	*	*	*	*	*	*	*	*	*	*	*	*
SA5	AS-AF-UJ-UF	*	*	*	*	*	*	*	*	*	*	*	*
TXBI	AS-AF-UJ-UF	*	*	*	*	*	*	*	*	*	*	*	*
T-TOUCH-I	AS-AF-UJ-UF	*	*	*	*	*	*	*	*	*	*	*	*
PTI2Z	AS-AF-UJ-UF	*	*	*	*	*	*	*	*	*	*	*	*
WMT21	AS-AF-UJ-UF	*	*	*	*	*	*	*	*	*	*	*	*
SWAI	AS-AF-UJ-UF	In combination with WMT21											
<b>VMF System</b>													
VMF-E2Z	AS-AF-UJ-UF	*	*	*	*	*	*	*	*	*	*	*	*
VMF-E4X	AS-AF-UJ-UF	*	*	*	*	*	*	*	*	*	*	*	*
VMF-E19I	AS-AF-UJ-UF-D*	*	*	*	*	*	*	*	*	*	*	*	*
VMF-IO	AS-AF-UJ-UF-D*	*	*	*	*	*	*	*	*	*	*	*	*
VMF-LON	AS-AF-UJ-UF-D*	*	*	*	*	*	*	*	*	*	*	*	*
VMF-SW	AS-AF-UJ-UF	*	*	*	*	*	*	*	*	*	*	*	*
VMF-SW1	AS-AF-UJ-UF	*	*	*	*	*	*	*	*	*	*	*	*
<b>Additional coil (heating only)</b>													
BV122	All	*											
BV132	All			*									
BV142	All					*		*					
BV7800	All									*			
BV162	All											*	
<b>Water valves **</b>													
<b>Valve Kit for 4 pipe systems with main coil</b>													
VC21X4L-R	AS-AF-UJ-UF(D+sist. VMF o DT)	*	*										
VC22X4L-R	AS-AF-UJ-UF(D+sist. VMF o DT)			*	*								
VC23X4L-R	AS-AF-UJ-UF(D+sist. VMF o DT)					*	*					*	*
<b>3 way valve kit</b>													
VCZ41/4124	All (1)	*	*										
VCZ42/4224	All (1)			*	*					*	*		
VCZ43/4324	All (1)					*	*					*	*
<b>2 way valve kit</b>													
VCZD1/124	All (1)	*	*										
VCZD2/224	All (1)			*	*		*	*	*	*	*		
VCZD3/324	All (1)					*	*					*	*
<b>Combined adjustment and balancing valve independent of pressure</b>													
VJP060	All	*	*	*	*								
VJP090	All					*	*	*	*				
VJP150	All									*	*	*	*
VJP060M	All (1)	*	*	*	*								
VJP090M	All (1)					*	*	*	*	*	*		
VJP150M	All (1)									*	*	*	*
<b>Installation accessories</b>													
AMP20	U	*	*	*	*	*	*	*	*	*	*	*	*
AMPZ	U	*	*	*	*	*	*	*	*	*	*	*	*
BCZ4	(vertical)	*	*	*	*	*	*	*	*	*	*	*	*
BCZ5	(horizontal)	*	*	*	*	*	*	*	*	*	*	*	*
BCZ6	(horizontal)											*	*
<b>Panel to dose rear of unit</b>													
PCZ200	All	*	*										
PCZ300	All			*	*								
PCZ500	All					*	*	*	*				
PCZ800	All									*	*		
PCZ1000	All											*	*
<b>Grille for ceiling mounted units</b>													
GA200	AS-AF-UJ-UF	*	*										
GA300	AS-AF-UJ-UF			*	*								
GA500	AS-AF-UJ-UF					*	*	*	*				
GA800	AS-AF-UJ-UF									*	*	*	*
<b>Esthetical and structural feet</b>													
ZXZ	All	*	*	*	*	*	*	*	*	*	*	*	*

For further details concerning control panels and VMF system refer to the dedicated sheets.

\* Contact Aermec

\*\*The water valves can be combined with the unit if it is also provided a control panel that controls

VJP / VJP\_M The compatibility of the valves in the hot branch plant 4 tubes, check with the design water flow

(1) VCZ4124-VCZ4224-VCZ4324-VCZD124-VCZD224-VCZD324-VJP060M-VJP090M-VJP150M are 24V

FCZI			Twin coil model									
			201	202	301	302	401	402	501	502	701	702
<b>Probes and accessories for control panels</b>												
AER503	AS-AF-U-UF		*	*	*	*	*	*	*	*	*	*
SW5	AS-AF-U-UF		*	*	*	*	*	*	*	*	*	*
SA5	AS-AF-U-UF		*	*	*	*	*	*	*	*	*	*
TXBI	AS-AF-U-UF		*	*	*	*	*	*	*	*	*	*
T-TOUCH-I	AS-AF-U-UF		*	*	*	*	*	*	*	*	*	*
PTI2Z	AS-AF-U-UF		*	*	*	*	*	*	*	*	*	*
WMT21	AS-AF-U-UF		*	*	*	*	*	*	*	*	*	*
SWAI	AS-AF-U-UF											
<b>VMF System</b>												
VMF-E2Z	AS-AF-U-UF		*	*	*	*	*	*	*	*	*	*
VMF-E4X	AS-AF-U-UF		*	*	*	*	*	*	*	*	*	*
VMF-E19I	AS-AF-U-UF		*	*	*	*	*	*	*	*	*	*
VMF-IO	AS-AF-U-UF		*	*	*	*	*	*	*	*	*	*
VMF-LON	AS-AF-U-UF		*	*	*	*	*	*	*	*	*	*
VMF-SW	AS-AF-U-UF		*	*	*	*	*	*	*	*	*	*
VMF-SW1	AS-AF-U-UF		*	*	*	*	*	*	*	*	*	*
<b>Water valves**</b>												
<b>3 way valve kit</b>												
VCZ41/4124	All	(1)	*	*								
VCZ42/4224	All	(1)			*	*	*	*	*	*	*	*
VCZ43/4324	All	(1)										*
<b>2 way valve kit</b>												
VCZD1/124	All	(1)	*	*								
VCZD2/224	All	(1)			*	*	*	*	*	*	*	*
VCZD3/324	All	(1)										*
<b>2 way valve kit for heating coil only</b>												
VCFD4/424	All	(1)	*	*	*	*	*	*	*	*	*	*
<b>Combined adjustment and balancing valve independent of pressure</b>												
VJP060	All		*	*	*	*	*	*	*	*	*	*
VJP150	All											*
VJP060M	All	(1)	*	*	*	*	*	*	*	*	*	*
VJP150M	All	(1)										*
<b>Installation accessories</b>												
AMP20	U		*	*	*	*	*	*	*	*	*	*
AMPZ	U		*	*	*	*	*	*	*	*	*	*
BC24	(vertical)		*	*	*	*	*	*	*	*	*	*
BC25	(horizontal)		*	*	*	*	*	*	*	*	*	*
BC26	(horizontal)											*
<b>Panel to close rear of unit</b>												
PCZ200	All		*	*								
PCZ300	All				*	*						
PCZ500	All					*	*	*	*			
PCZ800	All									*	*	
PCZ1000	All											*
<b>Grille for ceiling mounted units</b>												
GA200	U-UF		*	*								
GA300	U-UF				*	*						
GA500	U-UF					*	*	*	*			
GA800	U-UF									*	*	*
<b>Esthetical and structural feet</b>												
ZXZ	All		*	*	*	*	*	*	*	*	*	*

For further concerning control panels and VMF system refer to the dedicated sheets.

**\*\* The water valves can be combined with the unit if it is also provided a control panel that controls**

**VJP / VJP\_M The compatibility of the valves in the hot branch plant 4 tubes, check with the design water flow**

(1) VCZ4124-VCZ4224-VCZ4324-VCZD124-VCZD224-VCZD324-VJP60M-VJP090M-VJP150M are 24V

## TECHNICAL DATA - WITH SINGLE COIL

FCZI	200			250			300			350			400			450						
	H	M	L	H	M	L	H	M	L	H	M	L	H	M	L	H	M	L				
<b>Fan speed</b>																						
<b>Heating Performance</b>																						
<b>2 pipe systems</b>																						
Heating capacity (70°C)	(1)	kW		3,70	2,95	2,02	4,05	3,18	2,20	5,50	4,46	3,47	6,15	4,92	3,77	7,15	5,74	4,32	7,82	6,29	4,57	
Water flow rate	(1)	l/h		324	258	177	355	278	193	482	391	304	539	431	330	627	503	379	685	551	400	
Pressure drop	(1)	kPa		18,0	12,0	6,0	23,0	15,0	7,0	18,0	12,0	7,0	20,0	14,0	8,0	24,0	16,0	9,0	16,0	11,0	6,0	
Heating capacity (45°C)	(2)	kW		1,84	1,46	1,00	2,01	1,58	1,09	2,73	2,21	1,72	3,06	2,44	1,87	3,55	2,85	2,14	3,88	3,12	2,27	
Water flow rate	(2)	l/h		319	254	174	350	274	190	475	385	299	531	425	325	617	495	373	675	543	394	
Pressure drop	(2)	kPa		17,5	12,0	6,0	22,0	15,0	8,0	17,5	12,0	8,0	20,5	14,0	8,5	23,5	16,0	9,5	16,0	11,0	6,0	
<b>Cooling Performance</b>																						
Total cooling capacity	(3)	kW		1,60	1,28	0,89	1,94	1,55	1,06	2,65	2,17	1,68	3,02	2,46	1,89	3,60	2,92	2,20	4,03	3,21	2,41	
Sensible cooling capacity	(3)	kW		1,33	1,05	0,71	1,52	1,20	0,79	2,04	1,65	1,26	2,18	1,76	1,33	2,67	2,14	1,59	2,90	2,30	1,69	
Cooling capacity (latent)	(3)	kW		0,27	0,23	0,18	0,42	0,35	0,27	0,61	0,52	0,42	0,84	0,70	0,56	0,93	0,78	0,61	1,13	0,91	0,72	
Water flow rate	(3)	l/h		275	221	153	334	267	182	456	374	288	560	460	350	619	503	379	694	552	414	
Pressure drop	(3)	kPa		18,0	12,5	6,5	25,0	17,0	8,5	18,0	13,0	8,0	25,0	17,5	11,0	24,0	16,5	10,0	22,0	15,0	9,0	
<b>Fans</b>																						
Centrifugal Fans	n°	1						2						2								
Air flow rate	m³/h	290	220	140	290	220	140	450	350	260	450	350	260	600	460	330	600	460	330	600	460	330
<b>Sound level</b>																						
Sound power level	(4)	dB(A)		51	46	35	51	46	35	48	41	34	48	41	34	51	44	37	51	44	37	
Sound pressure level		dB(A)		43	38	27	43	38	27	40	33	26	40	33	26	43	36	29	43	36	29	
<b>Hydraulic connections</b>																						
<b>Main coil</b>																						
Standard	∅	1/2"			/			3/4"			/			3/4"			/					
Oversized	∅	/			1/2"			/			3/4"			/			3/4"					
<b>Electrical data</b>																						
Absorbed power	W	14	8	7	14	8	5	13	7	5	13	7	5	18	10	5	18	10	5	18	10	5
Signal 0-10V	%	90	68	44	90	68	44	90	70	52	90	70	52	90	68	49	90	68	49	90	68	49
Power supply	230V~50Hz																					

FCZI	500			550			700			750			900			950						
	H	M	L	H	M	L	H	M	L	H	M	L	H	M	L	H	M	L				
<b>Fan speed</b>																						
<b>Heating Performance</b>																						
<b>2 pipe systems</b>																						
Heating capacity (70°C)	(1)	kW		8,50	7,31	5,27	9,75	8,34	5,82	11,00	9,80	8,10	12,50	11,30	9,10	15,14	13,35	10,77	17,10	14,42	11,20	
Water flow rate	(1)	l/h		745	641	462	855	731	510	964	860	710	1096	991	798	1328	1171	945	1500	1264	982	
Pressure drop	(1)	kPa		28,0	21,0	12,0	26,0	20,0	10,0	29,1	23,6	16,8	18,0	15,0	10,0	22,0	17,4	12,0	33,0	24,5	15,5	
Heating capacity (45°C)	(2)	kW		4,22	3,63	2,62	4,85	4,14	2,89	5,47	4,87	4,03	6,20	5,60	4,50	7,53	6,64	5,35	8,50	7,17	5,57	
Water flow rate	(2)	l/h		734	631	455	842	720	502	950	846	699	1079	975	786	1307	1152	930	1476	1245	967	
Pressure drop	(2)	kPa		28,0	21,0	12,0	25,5	19,5	10,0	29,0	23,5	16,5	17,5	14,5	10,0	21,5	17,0	12,0	33,0	24,0	15,0	
<b>Cooling Performance</b>																						
Total cooling capacity	(3)	kW		4,25	3,69	2,68	4,79	4,13	2,91	5,50	4,89	3,92	6,14	5,34	4,27	6,91	5,00	4,29	8,60	7,32	5,77	
Sensible cooling capacity	(3)	kW		3,18	2,73	1,94	3,49	2,98	2,07	4,30	3,76	2,99	4,72	4,05	3,20	5,68	3,78	2,97	5,78	4,87	3,80	
Cooling capacity (latent)	(3)	kW		1,07	0,96	0,74	1,30	1,15	0,84	1,20	1,13	0,93	1,42	1,29	1,07	1,23	1,22	1,32	2,82	2,45	1,97	
Water flow rate	(3)	l/h		731	634	460	824	711	501	946	841	675	1056	918	734	1189	860	738	1479	1259	992	
Pressure drop	(3)	kPa		29,0	22,5	13,0	28,0	21,5	11,5	30,0	24,5	16,5	18,5	14,5	10,0	22,0	12,5	9,5	30,0	22,5	15,0	
<b>Fans</b>																						
Centrifugal Fans	n°	2						3						3								
Air flow rate	m³/h	720	600	400	720	600	400	1140	930	700	1140	930	700	1140	930	700	1140	930	700	1140	930	700
<b>Sound level</b>																						
Sound power level	(4)	dB(A)		56	51	42	56	51	42	62	57	50	62	57	50	62	57	51	61	57	51	
Sound pressure level		dB(A)		48	43	34	48	43	34	54	49	42	54	49	42	54	49	43	53	49	43	
<b>Hydraulic connections</b>																						
<b>Main coil</b>																						
Standard	∅	3/4"			/			3/4"			/			3/4"			/					
Oversized	∅	/			3/4"			/			3/4"			/			3/4"					
<b>Electrical data</b>																						
Absorbed power	W	19	10	4	19	10	4	80	40	30	80	40	30	80	40	30	80	40	30	80	40	30
Signal 0-10V	%	90	74	50	90	74	50	90	72	56	90	72	56	90	72	56	90	72	56	90	72	56
Power supply	230V~50Hz																					

**Data in accordance with Regulation EU 2016/2281**

H Maximum speed; M Average Speed; L Minimum speed

(1) Room air temperature 20°C d.b.; Water (in/out) 70°C/60°C;

(2) Room air temperature 20°C d.b.; Water (in/out) 45°C/40°C (EUROVENT)

(3) Room air temperature 27°C d.b./19°C w.b.; Water (in/out) 7°C/12°C (EUROVENT)

(4) Sound power: Aermec determines sound power values on the basis of measurements made in accordance with UNI EN 16583:15, as required for Eurovent certification.

Sound pressure level (A-weighted) measured indoors with volume V=85m³, reverberation time t = 0.5 s; Direction factor Q = 2; Distance r = 2.5m

## TECHNICAL DATA - WITH MAIN + SUPPLEMENTARY COIL

FCZI	201			301			401			501			701			901						
Fans speed	H	M	L	H	M	L	H	M	L	H	M	L	H	M	L	H	M	L				
<b>Heating Performance</b>																						
<b>4 pipe systems</b>																						
Heating capacity (65°)	(1)	kW			1,60	1,35	1,02	2,56	2,18	1,80	3,12	2,65	2,21	3,73	3,34	2,59	4,94	4,29	3,66	5,72	5,63	4,73
Water flow rate	(1)	l/h			140	118	89	224	191	158	273	232	186	327	293	227	437	375	320	501	492	414
Pressure drop	(1)	kPa			10,5	7,5	4,5	30,5	23,0	16,5	8,5	6,5	4,5	10,5	8,5	5,5	18,5	14,5	11,0	12,0	12,0	8,5
<b>Cooling Performance</b>																						
Total cooling capacity	(2)	kW			1,60	1,28	0,89	2,65	2,17	1,68	3,60	2,92	2,20	4,25	3,69	2,68	5,50	4,89	3,92	6,91	5,00	4,29
Sensible cooling capacity	(2)	kW			1,33	1,05	0,71	2,04	1,65	1,26	2,67	2,14	1,59	3,18	2,73	1,94	4,30	3,76	2,99	5,68	3,78	2,97
Cooling capacity (latent)	(2)	kW			0,27	0,23	0,18	0,61	0,52	0,42	0,93	0,78	0,61	1,07	0,96	0,74	1,20	1,13	0,93	1,23	1,22	1,32
Water flow rate	(2)	l/h			275	221	153	456	374	289	619	503	379	731	635	461	946	841	675	1188	860	738
Pressure drop	(2)	kPa			18,0	12,5	6,5	18,0	13,0	8,0	34,0	23,5	14,0	29,0	22,5	13,0	30,0	24,5	16,5	9,5	14,5	9,5
<b>Fans</b>																						
Centrifugal Fans	n°	1			2			2			2			3			3					
Air flow rate	m³/h	290	220	140	450	350	260	600	460	330	720	600	400	1140	930	700	1140	930	700			
<b>Sound level</b>																						
Sound power level	(3)	dB(A)			51	46	35	48	41	34	51	44	37	56	51	42	62	57	50	62	57	51
Sound pressure level		dB(A)			43	38	27	40	33	26	43	36	29	48	43	34	54	49	42	54	49	43
<b>Hydraulic connections</b>																						
Main coil	∅	1/2"			3/4"			3/4"			3/4"			3/4"			3/4"					
Additional coil	∅	1/2"			1/2"			1/2"			1/2"			1/2"			1/2"					
<b>Electrical data</b>																						
Absorbed power	W	14	8	7	13	7	5	18	10	5	19	10	4	80	40	30	80	40	30			
Signal 0-10V	%	90	68	44	90	70	52	90	68	49	90	74	50	90	72	56	90	72	56			
Power supply		230V~50Hz																				

## DIMENSIONS

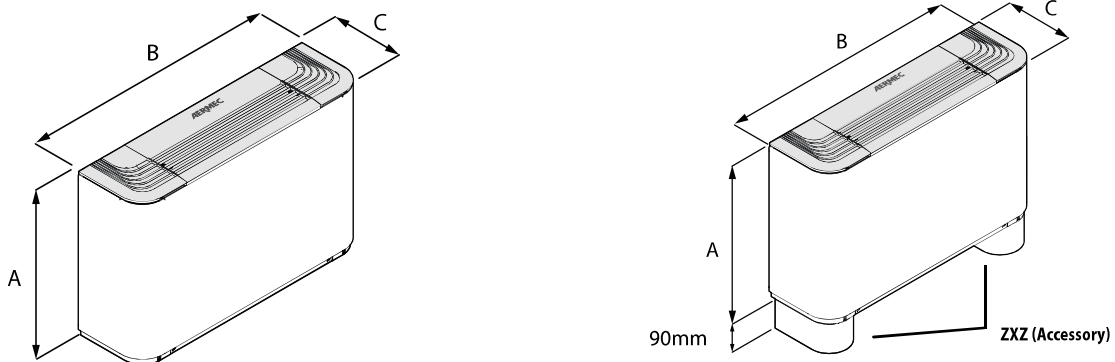

FCZI	200	201	202	250	300	301	302	350	400	401	402	450	500	501	502	550	700	701	702	750	900	901	/	950	
<b>Dimensions for all versions</b>																									
A	mm	486				486				486				486				486				591			
A (with feet)	mm	576				576				576				576				576				681			
B	mm	750				980				1200				1200				1320				1320			
C	mm	220				220				220				220				220				220			
Weight without feet	kg	15	15	16	16	17	17	18	18	22	23	24	24	22	23	24	24	29	30	31	31			34	

Aermec reserves the right to make any modifications deemed necessary. All data is subject to change without notice. Aermec does not assume responsibility or liability for errors or omissions.

**Aermec S.p.A.**

Via Roma, 996 - 37040 Bevilacqua (VR) - Italia  
Tel. 0442633111 - Telefax 044293577  
www.aermec.com