

# Haier SERVICE MANUAL

## Wall Mounted Type DC Inverter FREE MATCH N-Series Model No. AS18BS4HRA



### **WARNING**

This service information is designed for experienced repair technicians only and is not designed for use by the general public. It does not contain warnings or cautions to advise non-technical individuals of potential dangers in attempting to service a product. Products powered by electricity should be serviced or repaired only by experienced professional technicians. Any attempt to service or Repair the product or products dealt with in this service information by anyone else could result in serious injury or death

2015 (Qingdao Haier Air Conditioner General corp. , Ltd)  
All rights reserved. Unauthorized copying and distribution is a violation of law

---

## Contents

1. Introduction.....	1
2. Features .....	7
3. Specifications .....	8
4. Sensors list.....	9
5. Piping diagrams.....	10
6. Printed Circuit Board Connector Wiring Diagram.....	11
7. Functions and Control .....	14
8. System configuration.....	25
9. Dimensional drawings .....	33
10. Center of gravity .....	33
11. Service Diagnosis.....	34
12. Circuit diagrams .....	50

# 1 Introduction

## 1.1 Model name explanation

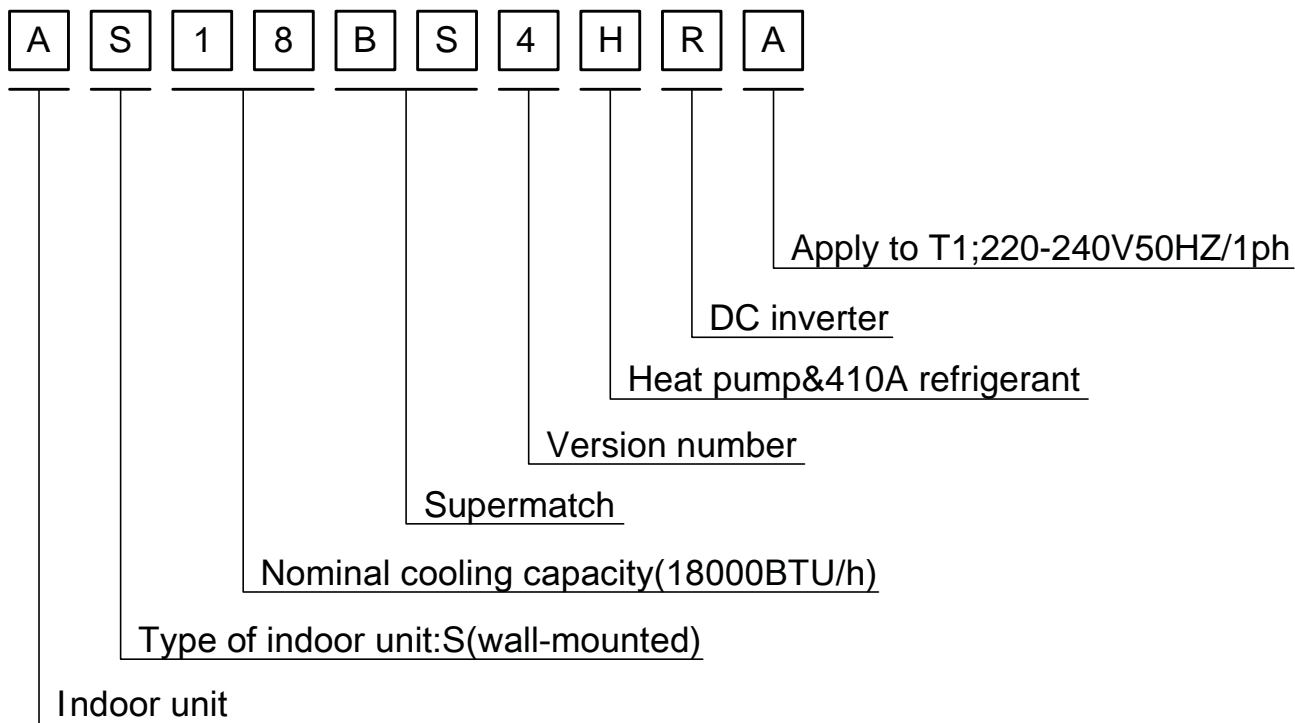

## 1.2 Safety Cautions

Be sure to read the following safety cautions before conducting repair work.

The caution items are classified into “Warning” and “Caution”. The “Warning” items are especially important since they can lead to death or serious injury if they are not followed closely. The “Caution” items can also lead to serious accidents under some conditions if they are not followed. Therefore, be sure to observe all the safety caution items described below.

About the pictograms

△ This symbol indicates an item for which caution must be exercised.

The pictogram shows the item to which attention must be paid.

○ This symbol indicates a prohibited action.





The prohibited item or action is shown inside or near the symbol.





● This symbol indicates an action that must be taken, or an instruction.

The instruction is shown inside or near the symbol.

After the repair work is complete, be sure to conduct a test operation to ensure that the equipment operates Normally, and explain the cautions for operating the product to the customer.

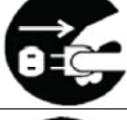

### 1.2.1 Caution in Repair

Warning	
<p>Be sure to disconnect the power cable plug from the plug socket before disassembling the equipment for a repair.</p> <p>Working on the equipment that is connected to a power supply can cause an electrical shock.</p> <p>If it is necessary to supply power to the equipment to conduct the repair or inspecting the circuits, do not touch any electrically charged sections of the equipment.</p>	
<p>If the refrigerant gas discharges during the repair work, do not touch the discharging refrigerant gas. The refrigerant gas can cause frostbite.</p>	
<p>When disconnecting the suction or discharge pipe of the compressor at the welded section, release the refrigerant gas completely at a well-ventilated place first.</p> <p>If there is a gas remaining inside the compressor, the refrigerant gas or refrigerating machine oil discharges when the pipe is disconnected, and it can cause injury.</p>	
<p>If the refrigerant gas leaks during the repair work, ventilate the area. The refrigerant gas can generate toxic gases when it contacts flames.</p>	
<p>The step-up capacitor supplies high-voltage electricity to the electrical components of the outdoor unit. Be sure to discharge the capacitor completely before conducting repair work. A charged capacitor can cause an electrical shock.</p>	
<p>Do not start or stop the air conditioner operation by plugging or unplugging the power cable plug. Plugging or unplugging the power cable plug to operate the equipment can cause an electrical shock or fire.</p>	

Warning	
Do not repair the electrical components with wet hands . Working on the equipment with wet hands can cause an electrical shock	
Do not clean the air conditioner by splashing water. Washing the unit with water can cause an electrical shock.	
Be sure to provide the grounding when repairing the equipment in a humid or wet place, to avoid electrical shock.	
Be sure to turn off the power switch and unplug the power cable when cleaning the equipment. The internal fan rotates at a high speed, and cause injury.	
Do not tilt the unit when removing it. The water inside the unit can spill and wet the furniture and floor.	
Be sure to check that the refrigerating cycle section has cooled down sufficiently before conducting repair work. Working on the unit when the refrigerating cycle section is hot can cause burns.	
Use the welder in a well-ventilated place. Using the welder in an enclosed room can cause oxygen deficiency.	



### 1.2.2 Cautions Regarding Products after Repair

Warning	
Be sure to use parts listed in the service parts list of the applicable model and appropriate tools to conduct repair work. Never attempt to modify the equipment. The use of inappropriate parts or tools can cause an electrical shock, excessive heat generation or fire.	
When relocating the equipment, make sure that the new installation site has sufficient strength to withstand the weight of the equipment. If the installation site does not have sufficient strength and if the installation work is not conducted securely, the equipment can fall and cause injury.	
Be sure to install the product correctly by using the provided standard installation frame. Incorrect use of the installation frame and improper installation can cause the equipment to fall, resulting in injury.	For integral units only
Be sure to install the product securely in the installation frame mounted on a window frame. If the unit is not securely mounted, it can fall and cause injury.	For integral units only

Warning	
<p>Be sure to use an exclusive power circuit for the equipment, and follow the technical standards related to the electrical equipment, the internal wiring regulations and the instruction manual for installation when conducting electrical work.</p> <p>Insufficient power circuit capacity and improper electrical work can cause an electrical shock or fire.</p>	
<p>Be sure to use the specified cable to connect between the indoor and outdoor units. Make the connections securely and route the cable properly so that there is no force pulling the cable at the connection terminals.</p> <p>Improper connections can cause excessive heat generation or fire.</p>	
<p>When connecting the cable between the indoor and outdoor units, make sure that the terminal cover does not lift off or dismount because of the cable.</p> <p>If the cover is not mounted properly, the terminal connection section can cause an electrical shock, excessive heat generation or fire.</p>	
<p>Do not damage or modify the power cable.</p> <p>Damaged or modified power cable can cause an electrical shock or fire. Placing heavy items on the power cable, and heating or pulling the power cable can damage the cable.</p>	
<p>Do not mix air or gas other than the specified refrigerant (R-410A / R22) in the refrigerant system.</p> <p>If air enters the refrigerating system, an excessively high pressure results, causing equipment damage and injury.</p>	
<p>If the refrigerant gas leaks, be sure to locate the leak and repair it before charging the refrigerant. After charging refrigerant, make sure that there is no refrigerant leak.</p> <p>If the leak cannot be located and the repair work must be stopped, be sure to perform pump-down and close the service valve, to prevent the refrigerant gas from leaking into the room. The refrigerant gas itself is harmless, but it can generate toxic gases when it contacts flames, such as fan and other heaters, stoves and ranges.</p>	
<p>When replacing the coin battery in the remote controller, be sure to disposed of the old battery to prevent children from swallowing it.</p> <p>If a child swallows the coin battery, see a doctor immediately.</p>	

Caution	
Installation of a leakage breaker is necessary in some cases depending on the conditions of the installation site, to prevent electrical shocks.	
Do not install the equipment in a place where there is a possibility of combustible gas leaks. If a combustible gas leaks and remains around the unit, it can cause a fire.	
Be sure to install the packing and seal on the installation frame properly. If the packing and seal are not installed properly, water can enter the room and wet the furniture and floor.	

### 1.2.3 Inspection after Repair

Warning	
Check to make sure that the power cable plug is not dirty or loose, then insert the plug into a power outlet all the way. If the plug has dust or loose connection, it can cause an electrical shock or fire.	
If the power cable and lead wires have scratches or deteriorated, be sure to replace them. Damaged cable and wires can cause an electrical shock, excessive heat generation or fire.	





Warning	
Do not use a joined power cable or extension cable, or share the same power outlet with other electrical appliances since it can cause an electrical shock, excessive heat generation or fire.	

<b>Caution</b>	
Check to see if the parts and wires are mounted and connected properly, and if the connections at the soldered or crimped terminals are secure. Improper installation and connections can cause excessive heat generation, fire or an electrical shock.	
If the installation platform or frame has corroded, replace it. Corroded installation platform or frame can cause the unit to fall, resulting in injury.	
Check the grounding, and repair it if the equipment is not properly grounded. Improper grounding can cause an electrical shock.	
Be sure to measure the insulation resistance after the repair, and make sure that the resistance is 1 M ohm or higher. Faulty insulation can cause an electrical shock.	
Be sure to check the drainage of the indoor unit after the repair. Faulty drainage can cause the water to enter the room and wet the furniture and floor.	

### 1.2.4 Using Icons

Icons are used to attract the attention of the reader to specific information. The meaning of each icon is described in the table below:

### 1.2.5 Using Icons List

Icon	Type of Information	Description
 Note	Note	A “note” provides information that is not indispensable, but may nevertheless be valuable to the reader, such as tips and tricks.
 Caution	Caution	A “caution” is used when there is danger that the reader, through incorrect manipulation, may damage equipment, lose data, get an unexpected result or has to restart (part of) a procedure.
 Warning	Warning	A “warning” is used when there is danger of personal injury.
	Reference	A “reference” guides the reader to other places in this binder or in this manual, where he/she will find additional information on a specific topic.



## 2.Features



Super quiet: Lower noise operation condition



A-PAM DC inverter:With adoption of S-TYPE,S-PAM and PHASE control technology to works more stably at low-frequency,and is more energy-saving,mor powerful at high frequency.



Long distance air supplying:



-15°C Heating: When -15°C can still heating natural



10°C heating maintenance:Heating Holding 10°C temperature



Comfortable sleep: The setting temperature and the indoor noise can be adjusted to a more comfortable level when you set the “sleep mode” during night sleep.



Super match:One outdoor unit can match two or more indoor unit.



DIY auto mode: Adjust the last fixed operation mode automatically.



Turbo mode: Quick cooling or heating



Auto restart: Automatic return to previous operation conditions after sudden power blackout



24 hours timer: Use the timer function to set on,or off,or from on to off,or from off to on.



Intergrative valve cover:The valve cover is Intergrative.



2-way piping design: The pipe can shoot out both from left or right side.



Easy clean design: The panel is easy to wash and the airflow vents can be detached easily



Double 8 display:The display is Double 8 mode.

### 3 Specifications

NOMINAL DISTRIBUTION SYSTEM VOLTAGE		
Phase	/	1
Frequency	Hz	50
Voltage	V	230

NOMINAL CAPACITY and NOMINAL INPUT			
		cooling	heating
Capacity rated	KW	5.2(1.3-6.8)	5.8(1.4-6.9)
	Btu/h	17740(4440-23200)	19790(4770-23500)
Power Consumption(Rated)	KW	1.53	1.71
SEER/SCOP	W/W	6.2	4.0
Annual energy consumption	KWh	293	1832
Moisture Removal	m <sup>3</sup> /h	2.0*10 <sup>-3</sup>	

TECHNICAL SPECIFICATIONS			
Dimensions	H*W*D	mm	997×235×322
Packaged Dimensions	H*W*D	mm	1085×329×403
Weight	/	KG	13
Gross weight	/	KG	16
Color	/	/	White
Sound level	Sound pressure(high/medium/low)	dB	44/40/35
	Sound power(high)	dB	57
			45/40/35
			58

TECHNICAL SPECIFICATIONS-PARTS				
			cooling	heating
Fan	Type		Cross flow fan	
	Motor output	W	40	40
	Air flow rate(high)	m <sup>3</sup> /h	900	900
	Speed(high/middle/low)	rpm	950/850/750	850/750/650
Heat exchanger	Type		ML fin- φ 7HI-HX tube	
	Segment *stage*fitch		3*18*1.4	
Air direction control			Right,Left,Horizontal,Downward	
Air filter			Removable/Washable/Mildew Proof	
Temperature control			Microcomputer Control	
Remote controller model			YR-HG	

Note: the data are based on the conditions shown in the table below

cooling	heating	Piping length
Indoor: 27°CDB/19°CWB Outdoor: 35°CDB/24°CWB	Indoor:20°CDB Outdoor: 7°CDB/6°CWB	5m

Conversation formulae
Kcal/h= KW×860
Btu/h= KW×3414
cfm=m <sup>3</sup> /min×35.3

## 4. Sensors list

type	Description	Qty
Room sensor	Its used for detecting room temperature	1
Pipe sensor	Its used for detecting temperature of evaporator	1

## 5. Piping diagrams

### Cooling mode

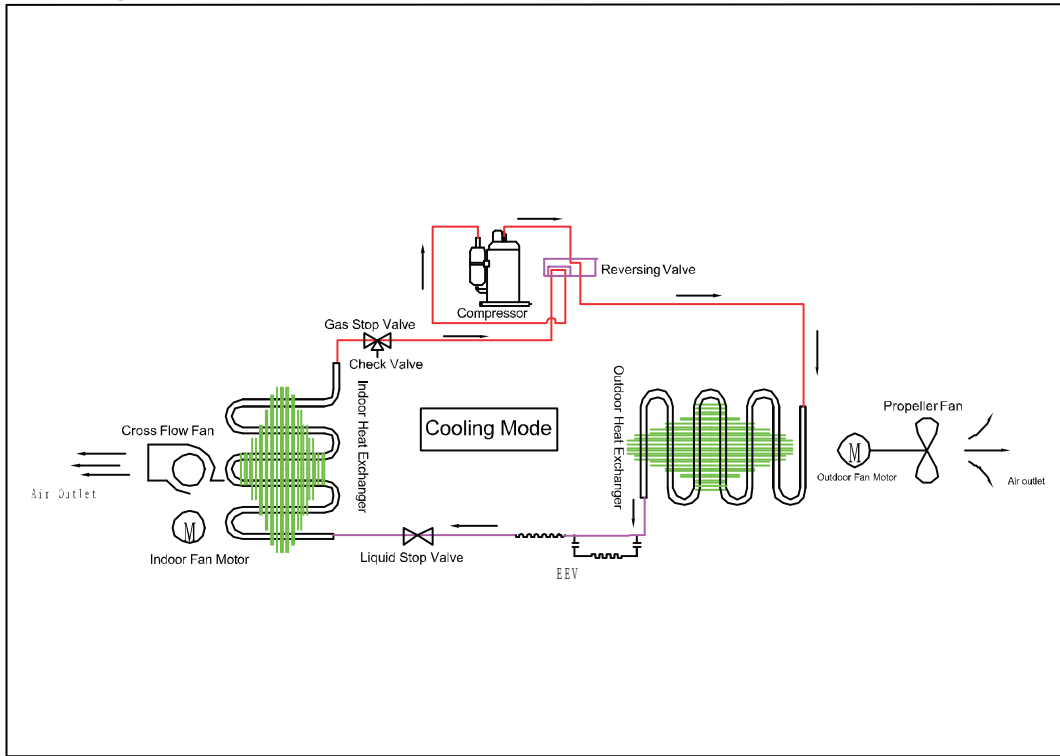

### Heating mode

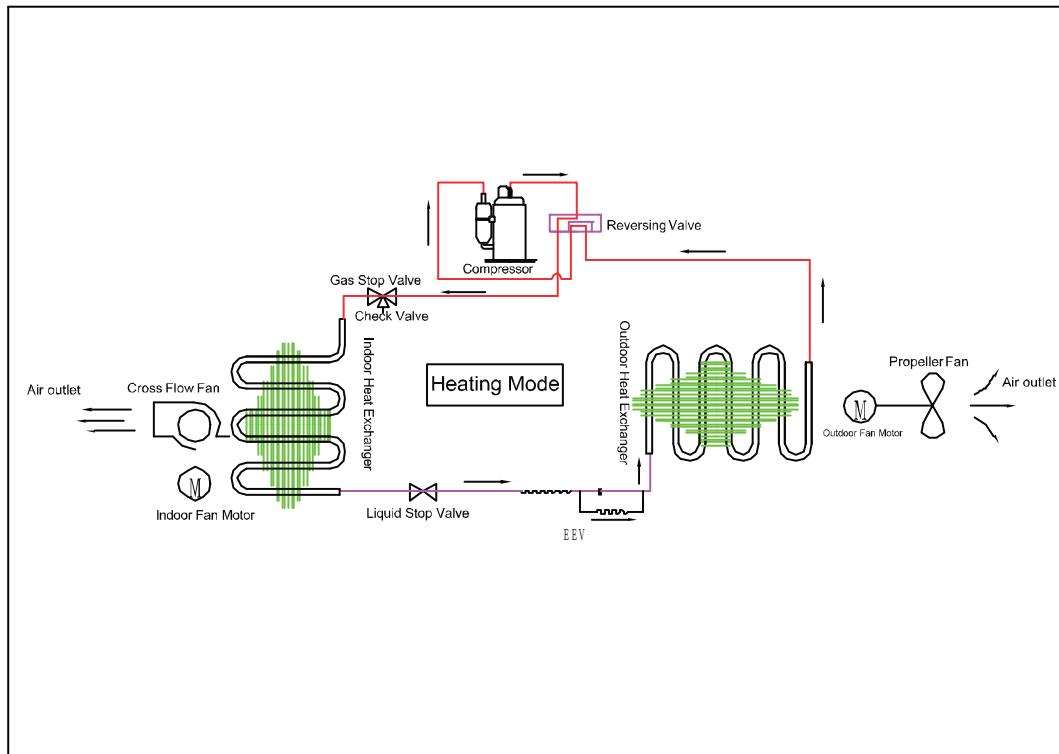

## 6. Printed Circuit Board Connector Wiring Diagram

### Connectors

#### PCB(1) (Control PCB)

series	PCB connector	Connect with load
1	CN9	Connector for fan motor
2	CN6	Connector for heat exchanger thermistor and Room temperature thermistor
3	CN5	Connector for UP&DOWN STEP motor
4	CN21	Connector for power N wire
5	CN52	Connector for power L
6	CN27	Connector for power GRN
7	CN7	Connector for display board
8	CN23	Connector for communicate between the indoor board and the outdoor board
9	CN34	Connector for long-range control

#### Note: Other designations

PCB(1) (Indoor Control PCB)

1) CN14 Connector for Forced operation ON / OFF switch

2) SW2 1 Select remote code A or B, 2 Select room card able or disable , 3-4 Select 23,26,33, or 35

3) RV1 Varistor

4) FUSE1 Fuse 3.15A/250VAC



Wiring diagrams

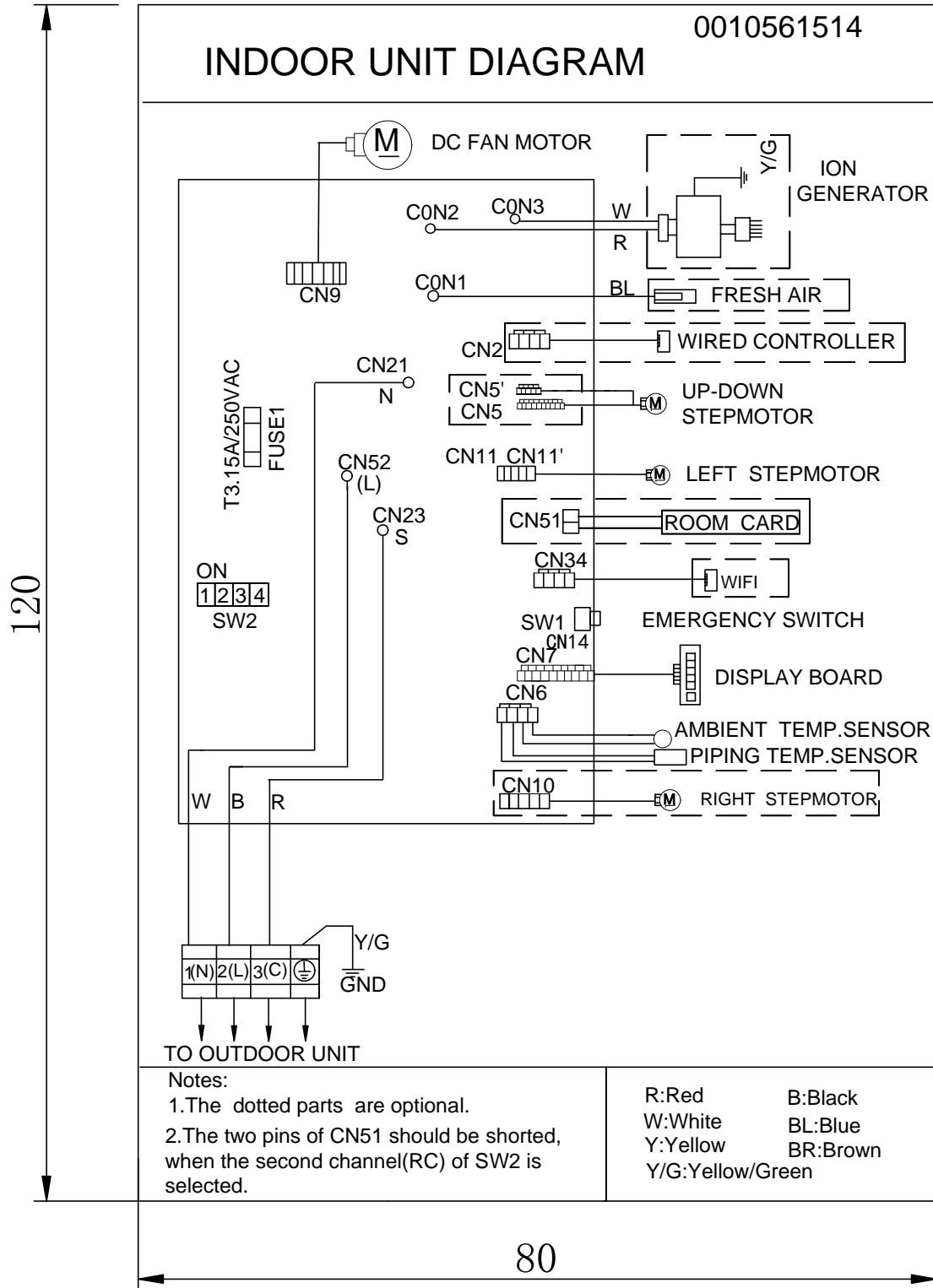

## 7.Functions and Control

### 7.1 Main functions and control specification

#### 7.1.1 Automatic operation

When the running mode is turned to automation after starting the system, the system will first determine the running mode according to the current room temperature and then will run according to the determined mode. Tr in the following selection conditions means room temperature, Ts means setting temperature, Tp means temperature of indoor coil pipe

$Tr \geq 23^{\circ}\text{C}$  Choose Cooling Mode

$Tr < 23^{\circ}\text{C}$  Choose Heating Mode

After turning to the automation mode, the running mode can be switched between cooling mode, fan mode and heating mode according to the change of the indoor ambient temperature. But the automatic conversion between cooling mode and heating mode must be conducted after 15 minutes.

#### 7.1.2 Cooling operation mode

Temperature control range:  $16^{\circ}\text{C} \text{---} 30^{\circ}\text{C}$

Temperature difference:  $\pm 1^{\circ}\text{C}$

\* Control features: When  $Tr(\text{input airflow}) > Ts(\text{set temperature})^{\circ}\text{C}$ , the compressor will be opened, the indoor fan will operate at the set speed and the mode signal will be sent to the outdoor system. When  $Tr(\text{input airflow}) < Ts(\text{set temperature})^{\circ}\text{C}$ , the compressor will be opened, the indoor fan will operate at the set speed and the mode signal will be sent to the outdoor system. The system will keep the original status if  $Tr = Ts$ .

Airflow speed control: (temperature difference  $1^{\circ}\text{C}$ )

Automatic: When  $Tr \geq Ts + 3^{\circ}\text{C}$ , high speed.

When  $Ts + 1^{\circ}\text{C} \leq Tr < Ts + 3^{\circ}\text{C}$ , medium speed

When  $Tr < Ts + 1^{\circ}\text{C}$ , low speed

When the sensor is off, low speed

When the airflow speed has no delay from the high to low switching, the speed should be delayed for 3 minutes (remain at high speed for 3 minutes.) before the next switch.

Manus: When the system is operating, you can set the high, medium or low speed manually. (When the sensor is on or off, the system will change the speed 2 seconds after receiving the signal.)

\* Airgate location control: the location for the airgate can be set according to your needs.

\* Defrosting function: preventing the frosting on the indoor heat exchanger (when cooling or dehumidifying). When the compressor works continuously for 1/6 minutes (adaptable in EEPROM) and the temperature of the indoor coils has been below zero centigrade for 10 seconds, the compressor will be stopped and the malfunction will be recorded in the malfunction list. The indoor system will continue to run. When the temperature of the indoor coil is raised to  $7^{\circ}\text{C}$ , the compressor will be restarted again (the requirement of 3 minutes' delay should be satisfied.)

\* timing system on/off function.

\* Dormant control function.



### 7.1.3 Demoisture mode.

\* temperature control range: 16---30°C

\* temperature difference:  $\pm 1^\circ\text{C}$

Control feature: send the demoisture signal to the outdoor system.

When  $T_r > T_s + 2^\circ\text{C}$ , the compressor will be turned on, the indoor fan will operate at the set speed.

When  $T_r$  is between the  $T_s$  and  $T_s + 2^\circ\text{C}$ , the outdoor system will operate at the high demoisture frequency for 10 minutes and then at the low demoisture mode for six minutes. The indoor fan will operate at low speed.

When  $T_r < T_s$ , the outsystem will be stopped, the indoor fan will be stopped for 3 minutes and then turned to the low speed option.

All the frequency converses have a  $\pm 1^\circ\text{C}$  difference.

\* Wind speed control: Automatic:

When  $T_r \geq T_s + 5^\circ\text{C}$ , high speed.

When  $T_s + 3^\circ\text{C} \leq T_r < T_s + 5^\circ\text{C}$ , medium speed.

When  $T_s + 2^\circ\text{C} \leq T_r < T_s + 3^\circ\text{C}$ , low speed.

When  $T_r < T_s + 2^\circ\text{C}$ , light speed.

If the outdoor fan stopped, the indoor fan will be paused for 3 minutes.

If the outdoor fan stopped for more than 3 minutes and the outdoor system still operates, the system will be changed into light speed mode.

When the airflow speed has no delay from the high to low switching, the speed should be delayed for 3 minutes (remain at high speed for 3 minutes.) before the next switch.

Manual: When the sensor is off or  $T_r < T_s + 3^\circ\text{C}$ , the manual operation can not be made. (obligatory automatic operation.)

\*Airgate location control: the location for the airgate can be set according to your needs.

\*Defrosting function: preventing the frosting on the indoor heat exchanger (when cooling or demoisture). When the compressor works continuously for 1/6 minutes (adaptable in EEPROM) and the temperature of the indoor coils has been below zero centigrade for 10 seconds, the compressor will be stopped and the malfunction will be recorded in the malfunction list. The indoor system will continue to run. When the temperature of the indoor coil is raised to  $7^\circ\text{C}$ , the compressor will be restarted again (the prerequisite of 3 minutes' delay should be satisfied.)

\* coil protection (synchronic overheating protection) are installed for the four directions latch malfunctions when demoisturing.

\* timing system on/off function.

\* Dormant control function.

### 7.1.4 Heating operation mode.

\* temperature control range: 16---30°C

\* temperature difference:  $\pm 1^\circ\text{C}$

\* control feature: the temperature compensation is automatically added and the system will send the heating signals to the outdoor system.

If  $T_r \leq T_s$ , the outdoor compressor is turned on, the indoor fan will be at the cold air proof mode.

If  $T_r > T_s + 1$ , the outdoor system is turned off, the indoor fan will be at the heat residue sending mode.

If  $T_r < T_s + 1$ , the outdoor system will be turned on again, the indoor fan will be at the cold air proof mode.

\*Indoor fan control

manual control: You can choose high, medium, low and automatic speed control.

Automatic: When  $T_r < T_s$ , high speed.

When  $T_s \leq T_r \leq T_s + 2^\circ\text{C}$ , medium speed.

When  $T_r > T_s + 2^\circ\text{C}$ , low speed.

When the airflow speed has no delay from the high to low switching, the speed should be delayed for 3 minutes (remain at high speed for 3 minutes.) before the next switch.

\*Airgate location control: the location for the airgate can be set according to your needs.

Coldair proof operation

1. The indoor operation within 4 minutes after the start up is as the following diagram, the air speed can be raised only after the speed has reached a certain level.

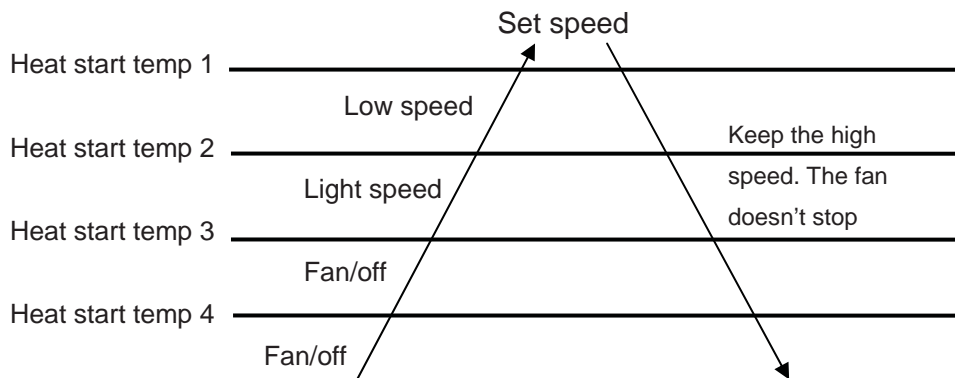

2. 4 minutes after the start up of the indoor fan, the light airflow and the low airflow will be turned to the set speed airflow.

3. In the cold air proof operation, the fan won't stop after the start up.

4. During the cold air proof operation, the indoor system will continuously send 'indoor high speed' signals to the outdoor system.

\* Residue heat sending. The indoor fan will send the residue heat at a low speed for 12 seconds.

If other conditions are satisfied, when the compressor stops, the indoor system will operate at a light speed. The indoor fan will stop when the coil temperature is below the 'heat start temp 4'.

\* Defrosting. When the system receives the defrosting signal from outdoors, the indoor fan will stop and the indoor temperature display won't change. At the time, any indoor coil malfunctions will be neglected. When the outdoor defrosting finishes, the coil malfunction will still be neglected until the compressor has been started up for 30 seconds. The indoor temperature display will not change and the system operates at the cold air proof mode.

\* Automatic heating temperature compensation: when the system enters the heating mode, the temperature compensation (4) will be added. When the status is switched off, the compensation will be erased.

### 7.1.5 Strength operation

The system enters the mode after receiving the 'strength signal'.

Send strength operation signal to the outdoor system.

The mode change finishes the strength operation.

Entering 'mute', you can have normal operation or signal control such as timing to finish the strength operation.

When the system is at the automatic option with the strength/ mute function, if the system enters the cooling mode, the cooling strength/ mute function will be offered; if the system enters the heating mode, then the heating strength/ mute function will be offered; if the system enters the airflow mode, there will be no strength/ mute function.

### 7.1.6 Mute operation

The system enters the mode after receiving the 'mute signal'.

- a. Mute heating: the airflow speed is slight, the system sends the mute signal to the outdoor system.
- b. mute cooling: the airflow speed is slight, the system sends the mute signal to the outdoor system.

When the compressor operates, the airflow speed is mute speed. EEPROM is adaptable.

Mute operation can not work under the dehumidifying and airflow-sending operation.

### 7.1.7 Air refreshing

After receiving the signal from the remote control, (HV series: the background light of the 'health' logo is green. HS series: the 'health' indicator will be lighted). If the fan operates, the Nano-Aqua operates to realize the ions sending function.

If the indoor fan stops, the Nano-Aqua is turned off.

When the Nano-Aqua is turned off, if the air refreshing system is turned on, the Nano-Aqua will be turned on when the fan operates.

### 7.1.8 Timing

You can set 24 hours' on/off timing accordingly. After the setting, the timing indicator will be lightened. Also, the light will be turning off after the timing is finished. The followings are several timing methods.

**1.system /on timing:** The timing indicator will be lightened and the indoor system is under the waiting mode. The light will be turned off when the timing is finished and the rest of the system will operate under a normal condition. The timing starts since the last reception of the timing signal.

**2.system /off timing:** When the system is turned on, the timing indicator is lightened, the rest of the system will operated under a normal condition. When set time comes, the indicator light will be turned off and the system will be turned off. If you have set the dormant functions, the order of your settings will be operated according to the timing settings.

**3 .system /on and off timing:** The settings will be completed according to the orders..

### 7.1.9 Dormant operation

The dormant timing is an eight hours unadaptable one. The timing signs are shown on the V series board. (RC series show the dormant signal, the timing light is lighted on the 6 lights board).

2.1 Under the cooling/ dehumidifying operation, after the setting of the dormant operation, the set temperature will be raised for 1 centigrade after 1 hour's operation and will be raised for 1 centigrade 1 hour later. The system will keep this status for 6 hours and then close.

2.2 Under the heating mode, after the setting of the dormant operation, the setting temperature will fall 2 centigrade after 1 hour's operation and will fall 2 centigrade 1 hour later. 3 hours after the preceding operations, the set temperature will be raised for 1 centigrade and the system will keep this status for 3 hours

and then close down.

2.3 During the dormant time, except the change of the system mode or a new press on the dormant setting keys, the timing of the 8 hours dormancy will take the first timing as the start time, any presses on other keys will not affect the original timing.

2.4 Indoor fan control under the dormant operation.

If the indoor fan is at the high speed before the dormant operation setting, the speed will be turned to medium after the setting. If the fan is at the medium speed before the dormant setting, the speed will be turned to low after the setting. If the fan is at the low speed before the dormant setting, the speed will not change.

### 7.1.10 Urgent on/off input

Press the urgency button the buzzer will ring. The system will enter the automatic mode if you don't press the button for more than 5 seconds.

Under the system off mode, if you press the urgency key for 5 to 10 seconds, the system will start the test operation.

Under the system off mode, if you press the urgency key for 10 to 15 seconds, the display screen will show the resume of the last malfunction.

If the system is under operation, the press on the urgency key will stop it.

Under the system off mode, the display screen will show automatic running sign.

Under the system off mode, the system will not receive the remote control signal if the press on the urgency key doesn't last for 15 seconds or if the key is loosened.

Urgency operation: If you press the urgency key for less than 5 seconds, the buzzer will ring when you press the on/off key. The system will enter the urgency operation when the urgency key is loosened. The urgency operation is fully automatic.

Test operation.

The inlet temperature sensor doesn't work, the indoor fan and the indoor air direction board motor works synchronically. High speed airflow, cooling, outdoor system on, etc, will send the ambient temperature 30 centigrade and coil temperature 16 centigrade information to the outdoor system.

Test operation

The defrost protection of the evaporator doesn't work.

The temperature control doesn't work.

The test operation will be finished in 30 minutes.

The test operation can be stopped by the relative commands from the remote control.

### 7.1.11 Low load protection control

In order to prevent the frosting of the indoor heat interaction device, the outdoor system will be stopped if the indoor heat interaction temperature is below zero centigrade for 5 minutes, but the fan will continue to operate. The outdoor system will be started again when the heat interaction temperature is above 7 centigrade and the system has been stopped for 3 minutes. The malfunction will be stored in the malfunction resume and will not be revealed.

### 7.1.12 High load protection control

The outdoor system will be stopped if the coil temperature is above 65°C for 2 minutes. The indoor fan will be

controlled by the thermostat. The outdoor system can be restarted when the coil temperature is below 42°C and the system has been stopped for 3 minutes. The malfunction will be stored in the malfunction resume and will not be revealed.

### 7.1.13 Abnormal operation of indoor system

When the outdoor system operates, if the indoor system operation differs from the outdoor system, the abnormal operation malfunction will be reported. 10s after the report, the indoor system will be closed.

Outdoor system mode	Indoor system mode	conflicts
cooling	heating	yes
cooling	cooling	no
cooling	airflow	no
heating	heating	no
heating	airflow	yes
heating	cooling	yes

### 7.1.14 Malfunction list resume.

Nothing is presented if there is no code list.

The malfunction display will automatically finish in 10 seconds.

The remote control only receives the signals for stop. According to the signals, the malfunction resume presentation finishes.

The resume restores after the power supply restores.

### 7.1.15 Abnormality confirmation approaches

**1. indoor temperature sensor abnormality:**

Under the operation, the normal temperature ranges from 120 degree to -30 degree. When the temperature goes beyond this range, the abnormality can be confirmed. If the temperature goes back into the range, the system will automatically resume.

**2 .indoor heat interaction sensor abnormality:**

Under the operation, the normal temperature ranges from 120 degree to -30 degree. When the temperature goes beyond this range, the abnormality can be confirmed. If the temperature goes back into the range, the system will automatically resume.

**3 .indoor malfunction:**

Outdoor malfunction: When the indoor system receives the outdoor malfunction codes, it will store the code into E2 for the malfunction list resume. The indoor system will continue to operate according to the original status, the malfunction code will not be revealed or processed.

**4. transmission abnormality:**

If the indoor system can't receive the outdoor system for 8 minutes, the communication abnormality can be confirmed and reported and the outdoor system will be stopped.

### 7.1.16 Single indoor system operation

\* Enter condition: First, set the high speed airflow and 30 centigrade set temperature, then press the dormant

keys for 6 times within 7 seconds, the system will feedback with 6 rings.

\* After the system enters the separate indoor system operation mode, the indoor system will operate according to the set mode and neglect the communication signals of the outdoor system. However, it has to send signals to the outdoor system.

\* Quitting condition: This mode can be quitted after receiving the quitting signal from the remote control or urgency system. The indoor system thus can quit the single operation mode.

### 7.1.17 Power cut compensation

\* Entering condition: Press dormant button 10 times within 7 second, the buzzer will ring 4 times and the present system status will be stored into the EEPROM of the indoor system.

\* After entering the power cut compensation mode, the processing of the indoor system should be as the followings:

Remote control urgency signal: operate according to the remote control and the urgent conditions, the present status will be stored into the EEPROM of the indoor system.

\* Quitting conditions: Press dormant button 10 times within 7 seconds and the buzzer will ring twice.

### 7.1.18 Fixed frequency operation

**1. Fixed cooling:** a. under G code condition: high speed cooling, set 16°C, press temperature '-' key and the set key at the same time. The system will enter the fixed frequency operation after the buzzer rings twice.

b. The proceeding programs are as the follows:

Entering the fixed frequency operation, you can set the fixed strength location 1 and send the cooling signal to the outdoor system. Meanwhile, you can fix the indoor system at high speed mode, the location of the airflow direction board can be switched to the maximal position.

c. Quitting condition: The fixed frequency cooling can be quitted after receiving the remote signal, and the system will enter the remote setting status.

**2. Fixed heating:** a. under G code condition: high speed heating, set 30°C, press temperature '+' key and the set key at the same time. The system will enter the fixed frequency operation after the buzzer rings twice.

b. The proceeding programs are as the follows:

Entering the fixed frequency operation, you can set the fixed strength location 1 and send the heating signal to the outdoor system. Meanwhile, you can fix the indoor system at high speed mode, the location of the airflow direction board can be switched to the maximal position.

c. Quitting condition: The fixed frequency heating can be quitted after receiving the remote signal, and the system will enter the remote setting status.

### 7.1.19 Test program

First, connect the test program terminal on the mainboard. Then connect the system to the power circuit. The test program will operate as follows.

HV series display: The buzzer rings for one time—the signal will be sent to outdoor system for 0.5 second—the violet is sent for 0.5-- the background light turns to white—the back ground light turns to white—the background light turns to white—the background light is fully lighted for 0.5 second—LED screen lights for 0.5 second—the step-in motor fully output for 0.5 second—then the motor doesn't output for 0.5 second—the motor fully output again for 0.5 second. The test program finishes.

### 7.1.20 Time cutting function:

Connect the test program terminal on the mainboard after connecting the system to the power circuit. The CPU of the main control will be 60 times faster.

## 7.2 Value of thermistor

### Room sensor and Pipe Sensor

R25°C=10KΩ ±3%

B25°C/50°C=3700K±3%

Temp.(°C)	Max.(KΩ)	Normal(KΩ)	Min.(KΩ)	Tolerance(°C)	
-30	165.2170	147.9497	132.3678	-1.94	1.75
-29	155.5754	139.5600	125.0806	-1.93	1.74
-28	146.5609	131.7022	118.2434	-1.91	1.73
-27	138.1285	124.3392	111.8256	-1.89	1.71
-26	130.2371	117.4366	105.7989	-1.87	1.70
-25	122.8484	110.9627	100.1367	-1.85	1.69
-24	115.9272	104.8882	94.8149	-1.83	1.67
-23	109.4410	99.1858	89.8106	-1.81	1.66
-22	103.3598	93.8305	85.1031	-1.80	1.64
-21	97.6556	88.7989	80.6728	-1.78	1.63
-20	92.3028	84.0695	76.5017	-1.76	1.62
-19	87.2775	79.6222	72.5729	-1.74	1.60
-18	82.5577	75.4384	68.8710	-1.72	1.59
-17	78.1230	71.5010	65.3815	-1.70	1.57
-16	73.9543	67.7939	62.0907	-1.68	1.55
-15	70.0342	64.3023	58.9863	-1.66	1.54
-14	66.3463	61.0123	56.0565	-1.64	1.52
-13	62.8755	57.9110	53.2905	-1.62	1.51
-12	59.6076	54.9866	50.6781	-1.60	1.49
-11	56.5296	52.2278	48.2099	-1.58	1.47
-10	53.6294	49.6244	45.8771	-1.56	1.46
-9	50.8956	47.1666	43.6714	-1.54	1.44
-8	48.3178	44.8454	41.5851	-1.51	1.42
-7	45.8860	42.6525	39.6112	-1.49	1.40

-6	43.5912	40.5800	37.7429	-1.47	1.39
-5	41.4249	38.6207	35.9739	-1.45	1.37
-4	39.3792	36.7676	34.2983	-1.43	1.35
-3	37.4465	35.0144	32.7108	-1.41	1.33
-2	35.6202	33.3552	31.2062	-1.38	1.31
-1	33.8936	31.7844	29.7796	-1.36	1.29
0	32.2608	30.2968	28.4267	-1.34	1.28
1	30.7162	28.8875	27.1431	-1.32	1.26
2	29.2545	27.5519	25.9250	-1.29	1.24
3	27.8708	26.2858	24.7686	-1.27	1.22
4	26.5605	25.0851	23.6704	-1.25	1.20
5	25.3193	23.9462	22.6273	-1.23	1.18
6	24.1432	22.8656	21.6361	-1.20	1.16
7	23.0284	21.8398	20.6939	-1.18	1.14
8	21.9714	20.8659	19.7982	-1.15	1.12
9	20.9688	19.9409	18.9463	-1.13	1.09
10	20.0176	19.0621	18.1358	-1.11	1.07
11	19.1149	18.2270	17.3646	-1.08	1.05
12	18.2580	17.4331	16.6305	-1.06	1.03
13	17.4442	16.6782	15.9315	-1.03	1.01
14	16.6711	15.9601	15.2657	-1.01	0.99
15	15.9366	15.2770	14.6315	-0.98	0.96
16	15.2385	14.6268	14.0271	-0.96	0.94
17	14.5748	14.0079	13.4510	-0.93	0.92
18	13.9436	13.4185	12.9017	-0.91	0.90
19	13.3431	12.8572	12.3778	-0.88	0.87
20	12.7718	12.3223	11.8780	-0.86	0.85
21	12.2280	11.8126	11.4011	-0.83	0.83
22	11.7102	11.3267	10.9459	-0.81	0.80
23	11.2172	10.8634	10.5114	-0.78	0.78
24	10.7475	10.4216	10.0964	-0.75	0.75
25	10.3000	10.0000	9.7000	-0.75	0.75
26	9.8975	9.5974	9.2980	-0.76	0.76
27	9.5129	9.2132	8.9148	-0.80	0.80
28	9.1454	8.8465	8.5496	-0.84	0.83
29	8.7942	8.4964	8.2013	-0.87	0.86
30	8.4583	8.1621	7.8691	-0.91	0.90
31	8.1371	7.8428	7.5522	-0.95	0.93
32	7.8299	7.5377	7.2498	-0.98	0.97
33	7.5359	7.2461	6.9611	-1.02	1.00
34	7.2546	6.9673	6.6854	-1.06	1.04
35	6.9852	6.7008	6.4222	-1.10	1.07
36	6.7273	6.4459	6.1707	-1.13	1.11
37	6.4803	6.2021	5.9304	-1.17	1.14
38	6.2437	5.9687	5.7007	-1.21	1.18



39	6.0170	5.7454	5.4812	-1.25	1.22
40	5.7997	5.5316	5.2712	-1.29	1.25
41	5.5914	5.3269	5.0704	-1.33	1.29
42	5.3916	5.1308	4.8783	-1.37	1.33
43	5.2001	4.9430	4.6944	-1.41	1.36
44	5.0163	4.7630	4.5185	-1.45	1.40
45	4.8400	4.5905	4.3500	-1.49	1.44
46	4.6708	4.4252	4.1887	-1.53	1.47
47	4.5083	4.2666	4.0342	-1.57	1.51
48	4.3524	4.1145	3.8862	-1.61	1.55
49	4.2026	3.9686	3.7443	-1.65	1.59
50	4.0588	3.8287	3.6084	-1.70	1.62
51	3.9206	3.6943	3.4780	-1.74	1.66
52	3.7878	3.5654	3.3531	-1.78	1.70
53	3.6601	3.4416	3.2332	-1.82	1.74
54	3.5374	3.3227	3.1183	-1.87	1.78
55	3.4195	3.2085	3.0079	-1.91	1.82
56	3.3060	3.0989	2.9021	-1.95	1.85
57	3.1969	2.9935	2.8005	-2.00	1.89
58	3.0919	2.8922	2.7029	-2.04	1.93
59	2.9909	2.7948	2.6092	-2.08	1.97
60	2.8936	2.7012	2.5193	-2.13	2.01
61	2.8000	2.6112	2.4328	-2.17	2.05
62	2.7099	2.5246	2.3498	-2.22	2.09
63	2.6232	2.4413	2.2700	-2.26	2.13
64	2.5396	2.3611	2.1932	-2.31	2.17
65	2.4591	2.2840	2.1195	-2.36	2.21
66	2.3815	2.2098	2.0486	-2.40	2.25
67	2.3068	2.1383	1.9803	-2.45	2.29
68	2.2347	2.0695	1.9147	-2.49	2.34
69	2.1652	2.0032	1.8516	-2.54	2.38
70	2.0983	1.9393	1.7908	-2.59	2.42
71	2.0337	1.8778	1.7324	-2.63	2.46
72	1.9714	1.8186	1.6761	-2.68	2.50
73	1.9113	1.7614	1.6219	-2.73	2.54
74	1.8533	1.7064	1.5697	-2.78	2.58
75	1.7974	1.6533	1.5194	-2.83	2.63
76	1.7434	1.6021	1.4710	-2.88	2.67
77	1.6913	1.5528	1.4243	-2.92	2.71
78	1.6409	1.5051	1.3794	-2.97	2.75
79	1.5923	1.4592	1.3360	-3.02	2.80
80	1.5454	1.4149	1.2942	-3.07	2.84
81	1.5000	1.3721	1.2540	-3.12	2.88
82	1.4562	1.3308	1.2151	-3.17	2.93
83	1.4139	1.2910	1.1776	-3.22	2.97

84	1.3730	1.2525	1.1415	-3.27	3.01
85	1.3335	1.2153	1.1066	-3.32	3.06
86	1.2953	1.1794	1.0730	-3.38	3.10
87	1.2583	1.1448	1.0405	-3.43	3.15
88	1.2226	1.1113	1.0092	-3.48	3.19
89	1.1880	1.0789	0.9789	-3.53	3.24
90	1.1546	1.0476	0.9497	-3.58	3.28
91	1.1223	1.0174	0.9215	-3.64	3.33
92	1.0910	0.9882	0.8942	-3.69	3.37
93	1.0607	0.9599	0.8679	-3.74	3.42
94	1.0314	0.9326	0.8424	-3.80	3.46
95	1.0030	0.9061	0.8179	-3.85	3.51
96	0.9756	0.8806	0.7941	-3.90	3.55
97	0.9490	0.8558	0.7711	-3.96	3.60
98	0.9232	0.8319	0.7489	-4.01	3.64
99	0.8983	0.8088	0.7275	-4.07	3.69
100	0.8741	0.7863	0.7067	-4.12	3.74
101	0.8507	0.7646	0.6867	-4.18	3.78
102	0.8281	0.7436	0.6672	-4.23	3.83
103	0.8061	0.7233	0.6484	-4.29	3.88
104	0.7848	0.7036	0.6303	-4.34	3.92
105	0.7641	0.6845	0.6127	-4.40	3.97
106	0.7441	0.6661	0.5957	-4.46	4.02
107	0.7247	0.6482	0.5792	-4.51	4.07
108	0.7059	0.6308	0.5632	-4.57	4.12
109	0.6877	0.6140	0.5478	-4.63	4.16
110	0.6700	0.5977	0.5328	-4.69	4.21
111	0.6528	0.5820	0.5183	-4.74	4.26
112	0.6361	0.5667	0.5043	-4.80	4.31
113	0.6200	0.5518	0.4907	-4.86	4.36
114	0.6043	0.5374	0.4775	-4.92	4.41
115	0.5891	0.5235	0.4648	-4.98	4.45
116	0.5743	0.5100	0.4524	-5.04	4.50
117	0.5600	0.4968	0.4404	-5.10	4.55
118	0.5460	0.4841	0.4288	-5.16	4.60
119	0.5325	0.4717	0.4175	-5.22	4.65
120	0.5194	0.4597	0.4066	-5.28	4.70

## 8 System configuration

### 8.1 System configuration

After the installation and test operation of the room air conditioner have been completed, it should be operated and handled as described below. Every user would like to know the correct method of operation of the room air conditioner, to check if it is capable of cooling(or heating) well, and to know a clever method of using it. In order to meet this expectation of the users, giving sufficient explanations taking enough time can be said to reduce about 80% of the requests for servicing. However good the installation work is and however good the functions are, the customer may blame either the room air conditioner or its installation work because of improper handling. The installation work and handing over of the unit can only be considered to have been completed when its handling has been explained to the user without using technical terms but giving full knowledge of the equipment.

### 8.2 Instruction

# Parts and Functions

## Indoor Unit

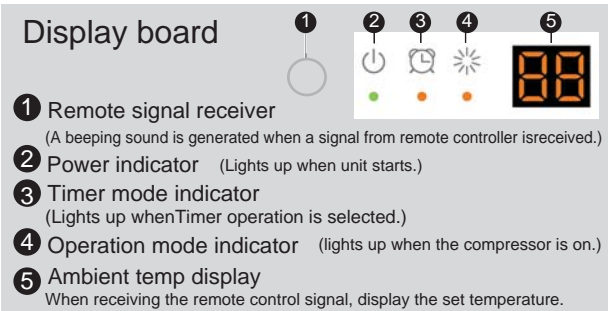
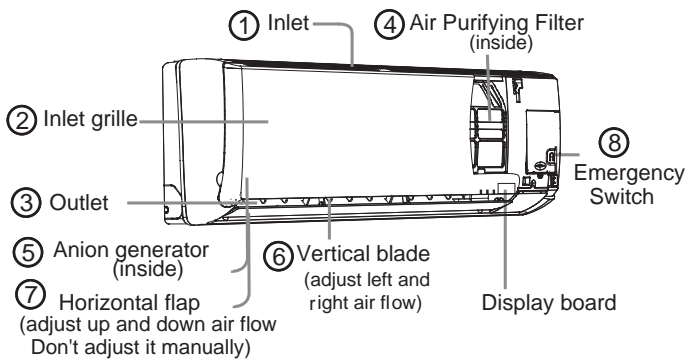

Actual inlet grille may vary from the one shown in the manual according to the product purchased

## Outdoor Unit

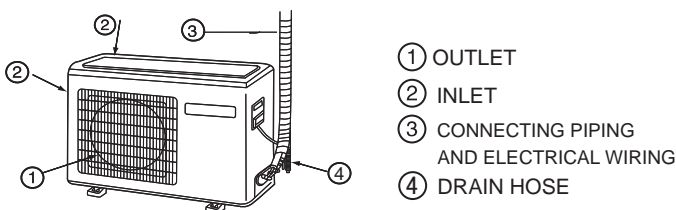

## Remote controller

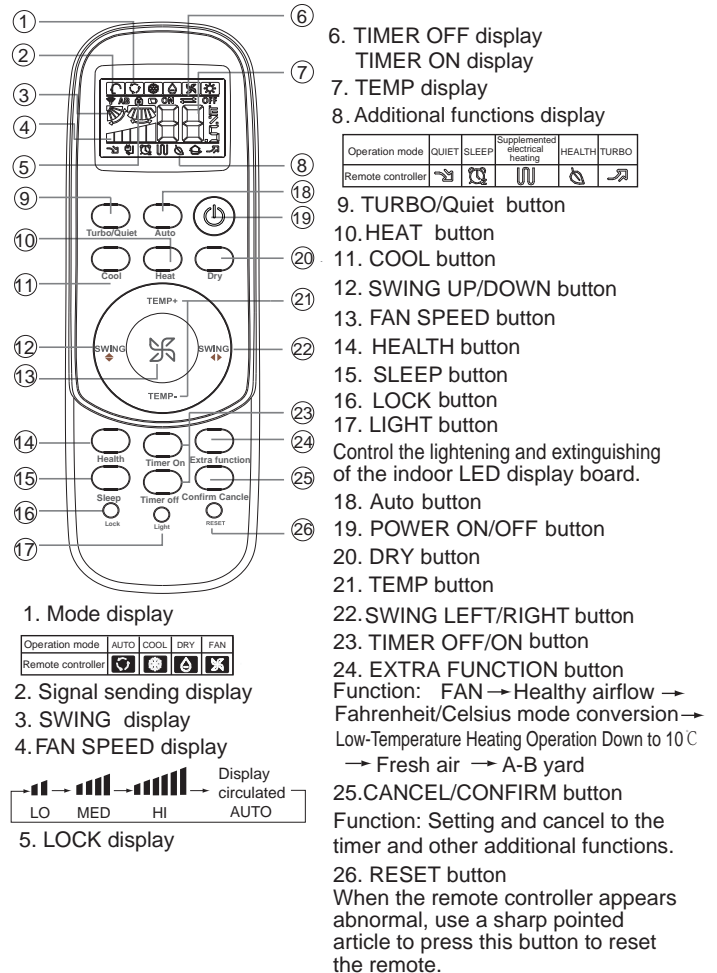

Healthy function is not available for some units.

# Operation

## Base Operation

Remote controller

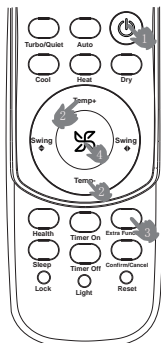

### 1. Unit start

Press ON/OFF on the remote controller, unit starts.

### 2. Select temp. setting

Press TEMP+ / TEMP- button

TEMP+ Every time the button is pressed, temp.setting increase 1°C,if kept depressed, it will increase rapidly

TEMP- Every time the button is pressed, temp.setting decrease 1°C,if kept depressed, it will decrease rapidly

Select a desired temperature.

### 3. Fan function

Press EXTRA FUNCTION button to enter additional options, when cycle display to , will flash. And then press enter to FAN function.

For each press button fan speed changes as follows:

Remote controller:

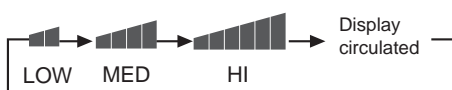

Air conditioner is running under displayed fan speed. When FAN is set to AUTO, the air conditioner automatically adjusts the fan speed according to room temperature.

Operation Mode	Remote Controller	Note
AUTO		Under the mode of auto operation, air conditioner will automatically select Cool or Heat operation according to room temperature. When FAN is set to AUTO, the air conditioner automatically adjusts the fan speed according to room temperature.
COOL		Cooling only unit do not have displays and functions related with heating
DRY		In DRY mode, when room temperature becomes lower than temp.setting+2°C,unit will run intermittently at LOW speed regardless of FAN setting.
HEAT		In HEAT mode,warm air will blow out after a short periodof the time due to cold-draft prevention function.
FAN		In FAN operation mode, the unit will not operate in COOL or HEAT mode but only in FAN mode ,AUTO is not available in FAN mode.And temp.setting is disabled. When FAN is set to AUTO, the air conditioner automatically adjusts the fan speed according to room temperature. In FAN mode,SLEEP operation is not available.

## Emergency operation and test operation

### Emergency Operation:

- Use this operation only when the remote controller is defective or lost, and with function of emergency running, air conditioner can run automatically for a while.
- When the emergency operation switch is pressed, the " Pi " sound is heard once, which means the start of this operation.
- When power switch is turning on for the first time and emergency operation starts, the unit will run automatically in the following modes:

Room temperature	Designated temperature	Timer mode	Fan speed	Operation mode
Above 23°C	26°C	No	AUTO	COOL



- It is impossible to change the settings of temp. and fan speed,It is also not possible to operate in timer or dry mode.

### Test operation:

Test operation switch is the same as emergency switch.

- Use this switch in the test operation when the room temperature is below 16°C, do not use it in the normal operation.
- Continue to press the test operation switch for more than 5 seconds. After you hear the "Pi" sound twice, release your finger from the switch: the cooling operation starts with the air flow speed "Hi".
- Under this operation mode,the fan motor of indoor unit will run in high speed.



## Air Flow Direction Adjustment

### 1. Status display of air flow Vertical flap

For each press of SWING button, remote controller displays as follows :

remote controller:

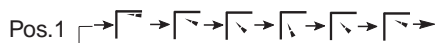

Initial state

Pos.2 No initial state displayed on remote controller, the vertical flap will be fixed on the current position

### 2. Left and right air flow adjustment

For each press of SWING button, remote controller displays as follows :

remote controller:



### Cautions:

- When adjusting the flap by hand,turn off the unit.
- When humidity is high,condensate water might occur adjusted to left or at air outlet if all vertical louvers are right.
- It is advisable not to keep horizontal flap at downward position for a long time in COOL or DRY mode , otherwise, condensate water might occur.

Note:

When restart after remote turning off, the remote controller will automatically memorize the previous set swing position.

# Operation

## Comfortable SLEEP

Press **SLEEP** button , the remote controller will show  , and then achieve to the sleep function. Press again this **SLEEP** button , the sleep function will be cancelled.

### Operation Mode

#### 1. In COOL, DRY mode

1 hours after SLEEP mode starts,temp.will become 1°C higher than temp.setting.After another 1 hours, temp.risesby 1°C futher .The unit will run for further 6 hours then stops Temp. is higher than temp.setting so that room temperature won't be too low for your sleep.

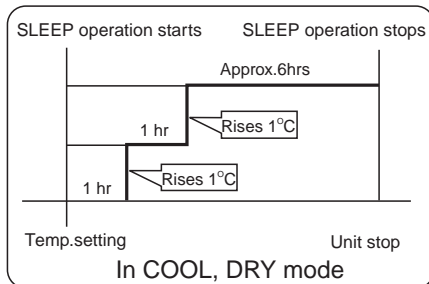

#### 2.In HEAT mode

1 hours after SLEEP mode starts, temp will become 2°C lower than temp.setting. After another 1 hours, temp decrease by 2°C further. After more another 3 hours, temp.risesby 1°C further.The unit will run for further 3 hours then stops.Temp. is lower than temp. setting so that room temperature won't be too high for your sleep.

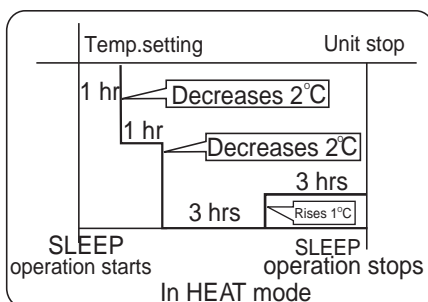

#### 3.In AUTO mode

The unit operates in corresponding sleep mode corresponding sleep mode adapted to the automatically selected operation mode.

#### 4. In FAN mode

It has no SLEEP function.

5. When quiet sleeping function is set to 8 hours the quiet sleeping time can not be adjusted.When TIMER function is set,the quiet sleeping function can't be set up.After the sleeping function is set up,if user resets TIMER function, the sleeping function will be cancelled; the machine will be in the state of timing-on,if the two modes are set up at the same time,either of their operation time is ended first,the unit will stop automatically,and the other mode will be cancelled.

### Note

When TIMER function is set, the sleeping function can't be set up .After the sleeping function is set up,if user resets TIMER function, the sleeping function will be cancelled; the machine will be in the state of timing-on.

#### Note to the power failure resume:

Press the sleep button ten times in five seconds and enter function after hearing four sounds.And press the sleep button ten times within five seconds and leave this function after hearing two sounds.

#### Power Failure Resume Function

If the unit is started for the first time, the compressor will not start running unless 3 minutes have elapsed. When the power resumes after power failure, the unit will run automatically, and 3 minutes later the compressor starts running.

## Healthy airflow Operation

#### 1.Press to starting

Setting the comfort work conditions.

#### 2.The setting of healthy airflow function

Press **EXTRA FUNCTION** button to enter additional options,Press this button continuously, the louvers location will cycle between in the following three locations, to choose the swing location what you needed,and then press **CONFIRM/CANCEL** button to confirm.



#### 3.The cancel of the healthy airflow function

Press **EXTRA FUNCTION** button to enter additional options,Press this button continuously, the louvers location will cycle between in the following three locations again,and then press **CONFIRM/CANCEL** button to cancel.

Notice: Do not direct the flap by hand. Otherwise, the grille will run incorrectly. If the grille is not run correctly, stop for a minute and then start, adjusting by remote controller.

### Note:

- 1.After setting the healthy airflow function, the position grill is fixed.
- 2.In cooling, it is better to select the  mode.
- 3.In cooling and dry, using the air conditioner for a long time under the high air humidity, condensate water may occur at the grille .

# Operation

## Timer On/Off On-Off Operation

1. After unit starts, select your desired operation mode.

2. Press  /  button to change TIMER mode.

Press  button "ON 0.5" will appear ,after 10 seconds the time display will be blank.

Press  button "OFF 0.5" will appear ,after 10 seconds the time display will be blank.

Then select your desired TIMER mode (TIMER ON or TIMER OFF ). " ON "or " OFF "will flash.

3. Press  /  button to set time.

Press the button for each time, setting time in the first 12 hours increased by 0.5 hour every time, after 12 hours,increased by 1 hour every time.

4. Confirm timer setting

After adjust the time,pres  button and confirm the time ON or OFF button will not flash any more.

5. Cancel timer setting

Press the  button the time display eliminated.

Hints:

After replacing batteries or a power failure happens, time setting should be reset.

According to the Time setting sequence of TIMER ON or TIMER OFF, either Start-Stop or Stop-Start can be achieved.

## HEALTH Operation

(This function is unavailable on some models.)

Press HEALTH button , the remote controller will show  and then achieve to the health function.

Press again this HEALTH button , the health function will be cancelled.

The anion generator in the airconditioner can generate a lot of anion effectively balance the quantity of position and anion in the air and also to kill bacteria and speed up the dust sediment in the room and finally clean the air in the room.

## TURBO Operation

(This function is unavailable on some models.)

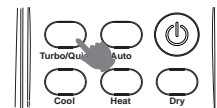

When you need fast cool or fast dehumidification,you can choose the Turob function; when you sleep, read, you can choose Quiet function

Press the  button, you can switch the "Turbo" and "Quiet" function easily. Eevery press,the remote controller will swith as below



When running in Turbo , the fan speed is the highest, when running in Quiet, the fan speed is super slow

## Loading of the battery

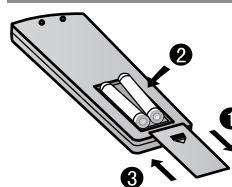







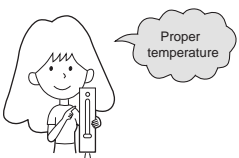
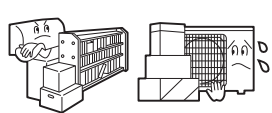

- 1 Remove the battery cover;
- 2 Load the batteries as illustrated. 2 R-03 batteries, resetting key (cylinder);
- 3 Be sure that the loading is in line with the "+" "-";
- 4 Load the battery,then put on the cover again.

Note:

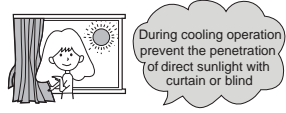
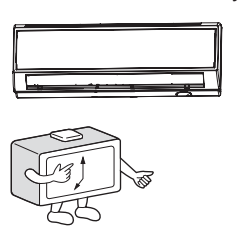

- The distance between the signal transmission head and the receiver hole should be within 7m without any obstacle as well.
- When electronic-started type fluorescent lamp or change-over type fluorescent lamp or wireless telephone is installed in the room, the receiver is apt to be disturbed in receiving the signals, so the distance to the indoor unit should be shorter.
- Full display or unclear display during operation indicates the batteries have been used up. Please change batteries.
- If the remote controller can't run normally during operation, please remove the batteries and reload several minutes later.

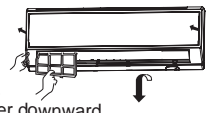
# Maintenance

## For Smart Use of The Air Conditioner

<p><b>Setting of proper room temperature</b></p> 	<p><b>Do not block the air inlet or outlet</b></p> 	<p><b>Remote Controller</b></p>  <p>Do not use water, wipe the controller with a dry cloth. Do not use glass cleaner or chemical cloth.</p>	<p><b>Indoor Body</b></p>  <p>wipe the air conditioner by using a soft and dry cloth. For serious stains, use a neutral detergent diluted with water. Wring the water out of the cloth before wiping, then wipe off the detergent completely.</p>
<p><b>Close doors and windows during operation</b></p> 	<p><b>Use the timer effectively</b></p> 	<p><b>Do not use the following for cleaning</b></p>  <p>Gasoline, benzene, thinner or cleanser may damage the coating of the unit. Hot water over 40°C (104°F) may cause discoloring or deformation.</p>	
<p><b>If the unit is not to be used for a long time, turn off the power supply main switch.</b></p> 	<p><b>Use the louvers effectively</b></p> 	<p><b>Air Filter cleaning</b></p> <ol style="list-style-type: none"> <li>Open the inlet grille by pulling it upward.</li> <li>Remove the filter. Push up the filter's center tab slightly until it is released from the stopper, and remove the filter downward.</li> <li>Clean the filter. Use a vacuum cleaner to remove dust, or wash the filter with water. After washing, dry the filter completely in the shade.</li> <li>Attach the filter. Attach the filter correctly so that the "FRONT" indication is facing to the front. Make sure that the filter is completely fixed behind the stopper. If the right and left filters are not attached correctly, that may cause defects.</li> <li>Close the inlet grille.</li> </ol>  	

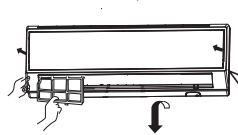
## Replacement of Air Purifying Filter

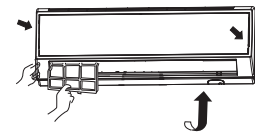
<p><b>1. Open the Inlet Grille</b> Prop up the inlet grille by using a small device named grille-support which located in the right side of the indoor unit.</p>  <p><b>2. Detach the standard air filter</b> Slide the knob slightly upward to release the filter, then withdraw it.</p>  <p><b>3. Attach Air Purifying Filter</b> Put air purifying filter appliances into the right and left filter frames.</p> 	<p><b>4. Attach the standard air filter</b> (Necessary installation)</p>  <p><b>ATTENTION:</b> The white side of the photocatalyst air purifying filter face outside, and the black side face the unit. The green side of the bacteria-killing medium air purifying filter face outside, and the white side face the unit.</p> <p><b>5. Close the Inlet Grille</b> Close the Grille surely</p> <p><b>NOTE:</b></p> <ul style="list-style-type: none"> <li>The photocatalyst air purifying filter will be solarized in fixed time. In normal family, it will be solarized every 6 months.</li> <li>The bacteria-killing medium air purifying filter will be used for a long time, no need for replacement. But in the period of using them, you should remove the dust frequently by using vacuum cleaner or flapping them lightly, otherwise, its performance will be affected.</li> <li>Please keep the bacteria-killing medium air purifying filter in the cool and dry conditions avoid long time directly sunshine when you stop using it, or its ability of sterilization will be reduced.</li> </ul>
--	---













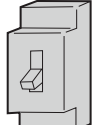

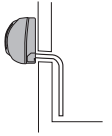





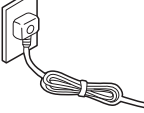

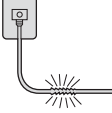

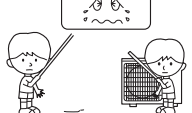
# Cautions





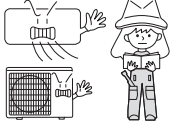

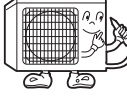



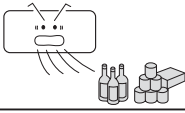

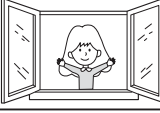

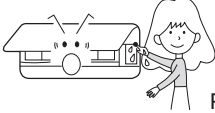

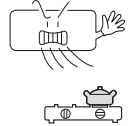
## ⚠ WARNING

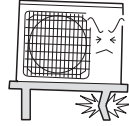
Please call Sales/Service Shop for the Installation.  
Do not attempt to install the air conditioner by yourself because improper works may cause electric shock, fire, water leakage.

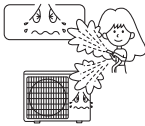
## ⚠ WARNING



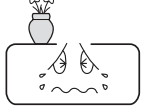

<p>When abnormality such as burnt-small found, immediately stop the operation button and contact sales shop.</p>  OFF   STRICT ENFORCEMENT	<p>Use an exclusive power source with a circuit breaker</p> 	<p>Check proper installation of the drainage securely</p>  STRICT ENFORCEMENT 	
<p>Connect power supply cord to the outlet completely</p>  STRICT ENFORCEMENT 	<p>Use the proper voltage</p>  STRICT ENFORCEMENT 	<p>1. Do not use power supply cord extended or connected in halfway 2. Do not install in the place where there is any possibility of inflammable gas leakage around the unit. 3. Do not get the unit exposed to vapor or oil steam.</p>  PROHIBITION	
<p>Do not use power supply cord in a bundle.</p>  PROHIBITION 	<p>Take care not to damage the power supply cord.</p>  PROHIBITION 	<p>Do not insert objects into the air inlet or outlet.</p>  PROHIBITION 	
<p>Do not start or stop the operation by disconnecting the power supply cord and so on.</p>  PROHIBITION 	<p>Do not channel the air flow directly at people, especially at infants or the aged.</p>  PROHIBITION 	<p>Do not try to repair or reconstruct by yourself.</p>  PROHIBITION 	<p>Connect the earth cable.</p>  earthing 

## ⚠ CAUTION

<p>Do not use for the purpose of storage of food, art work, precise equipment, breeding, or cultivation.</p>  PROHIBITION 	<p>Take fresh air occasionally especially when gas appliance is running at the same time.</p>  STRICT ENFORCEMENT 	<p>Do not operate the switch with wet hand.</p>  PROHIBITION 
<p>Do not install the unit near a fireplace or other heating apparatus.</p>  PROHIBITION 	<p>Check good condition of the installation stand</p>  PROHIBITION 	<p>Do not pour water onto the unit for cleaning</p>  PROHIBITION 
<p>Do not place animals or plants in the direct path of the air flow</p>  PROHIBITION 	<p>Do not place any objects on or climb on the unit.</p>  PROHIBITION 	<p>Do not place flower vase or water containers on the top of the unit.</p>  PROHIBITION 

# Trouble shooting

Before asking for service, check the following first.

	Phenomenon	Cause or check points
Normal Performance inspection	The system does not restart immediately. 	<ul style="list-style-type: none"> <li>When unit is stopped, it won't restart immediately until 3 minutes have elapsed to protect the system.</li> <li>When the electric plug is pulled out and reinserted, the protection circuit will work for 3 minutes to protect the air conditioner.</li> </ul>
	Noise is heard 	<ul style="list-style-type: none"> <li>During unit operation or at stop, a swishing or gurgling noise may be heard. At first 2-3 minutes after unit start, this noise is more noticeable. (This noise is generated by refrigerant flowing in the system.)</li> <li>During unit operation, a cracking noise may be heard. This noise is generated by the casing expanding or shrinking because of temperature changes.</li> <li>Should there be a big noise from air flow in unit operation, air filter may be too dirty.</li> </ul>
	Smells are generated.	<ul style="list-style-type: none"> <li>This is because the system circulates smells from the interior air such as the smell of furniture, paint, cigarettes.</li> </ul>
	Mist or steam are blown out. 	<ul style="list-style-type: none"> <li>During COOL or DRY operation, indoor unit may blow out mist. This is due to the sudden cooling of indoor air.</li> </ul>
	In dry mode, fan speed can't be changed.	<ul style="list-style-type: none"> <li>In DRY mode, when room temperature becomes lower than temp. setting+2 °C, unit will run intermittently at LOW speed regardless of FAN setting.</li> </ul>
Multiple check		<ul style="list-style-type: none"> <li>Is power plug inserted?</li> <li>Is there a power failure?</li> <li>Is fuse blownout?</li> </ul>
	Poor cooling 	<ul style="list-style-type: none"> <li>Is the air filter dirty? Normally it should be cleaned every 15 days.</li> <li>Are there any obstacles before inlet and outlet?</li> <li>Is temperature set correctly?</li> <li>Are there some doors or windows left open?</li> <li>Is there any direct sunlight through the window during the cooling operation?(Use curtain)</li> <li>Are there too much heat sources or too many people in the room during cooling operation?</li> </ul>

# Cautions

- Do not obstruct or cover the ventilation grille of the air conditioner. Do not put fingers or any other things into the inlet/outlet and swing louver.
- This appliance is not intended for use by persons (including children) with reduced physical, sensory or mental capabilities or lack of experience and knowledge, unless they have been given supervision or instruction concerning use of appliance by person responsible for their safety. Children should be supervised to ensure that they do not play with the appliance.

## Specifications

- The refrigerating circuit is leak-proof.

The machine is adaptive in following situation

1. Applicable ambient temperature range:

Cooling	Indoor	Maximum:D.B/W.B 32°C/23°C Minimum:D.B/W.B 21°C/15°C
	Outdoor	Maximum:D.B/W.B 46°C/26°C Minimum: D.B 18°C
Heating	Indoor	Maximum:D.B 27°C Minimum: D.B 15°C
	Outdoor	Maximum:D.B/W.B 24°C/18°C Minimum:D.B/W.B -7°C/-8°C
	Outdoor (INVERTER)	Maximum:D.B/W.B 24°C/18°C Minimum:D.B -15°C

- If the power supply cord is damaged, it must be replaced by the manufacturer or its service agent or a similar qualified person.
- If the fuse of indoor unit on PC board is broken, please change it with the type of T. 3.15A/ 250V. If the fuse of outdoor unit is broken, change it with the type of T.25A/250V
- The wiring method should be in line with the local wiring standard.
- After installation, the power plug should be easily reached.
- The waste battery should be disposed properly.
- Please employ the proper power plug, which fit into the power supply cord.
- The power plug and connecting cable must have acquired the local attestation.
- In order to protect the units, please turn off the A/C first, and at least 30 seconds later, cutting off the power.
- Please check the installation instruction of WiFi in the WiFi module

## 9. Dimensional drawings

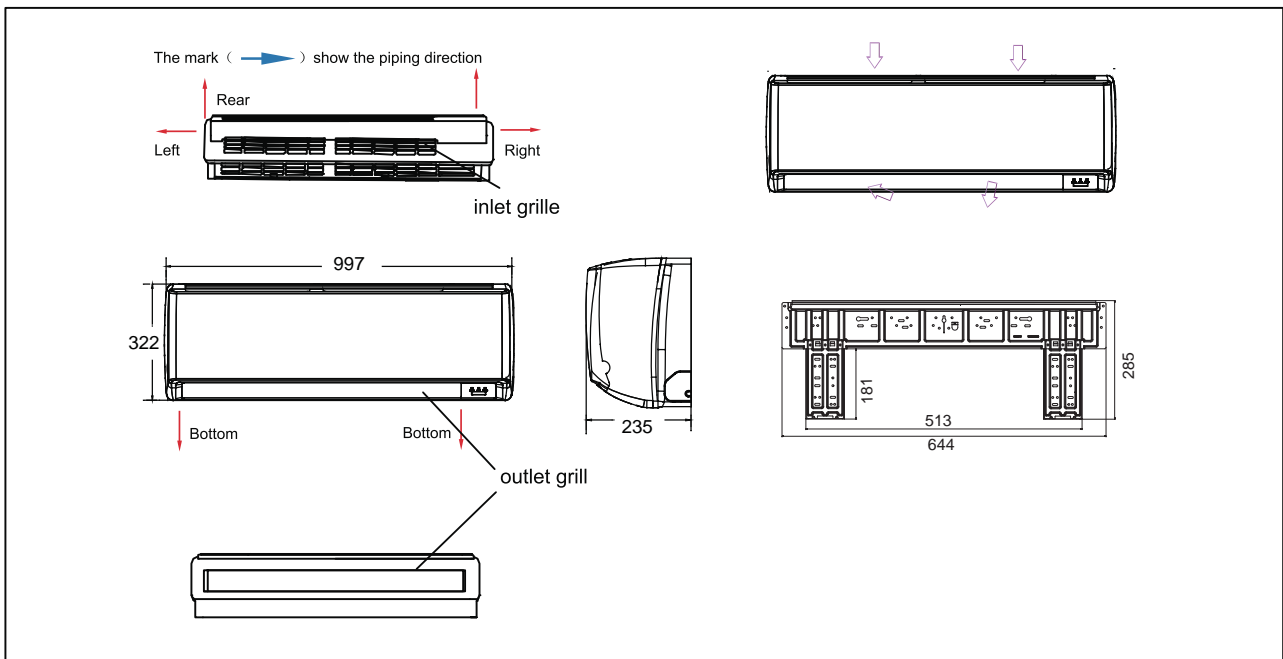

## 10. Center of gravity

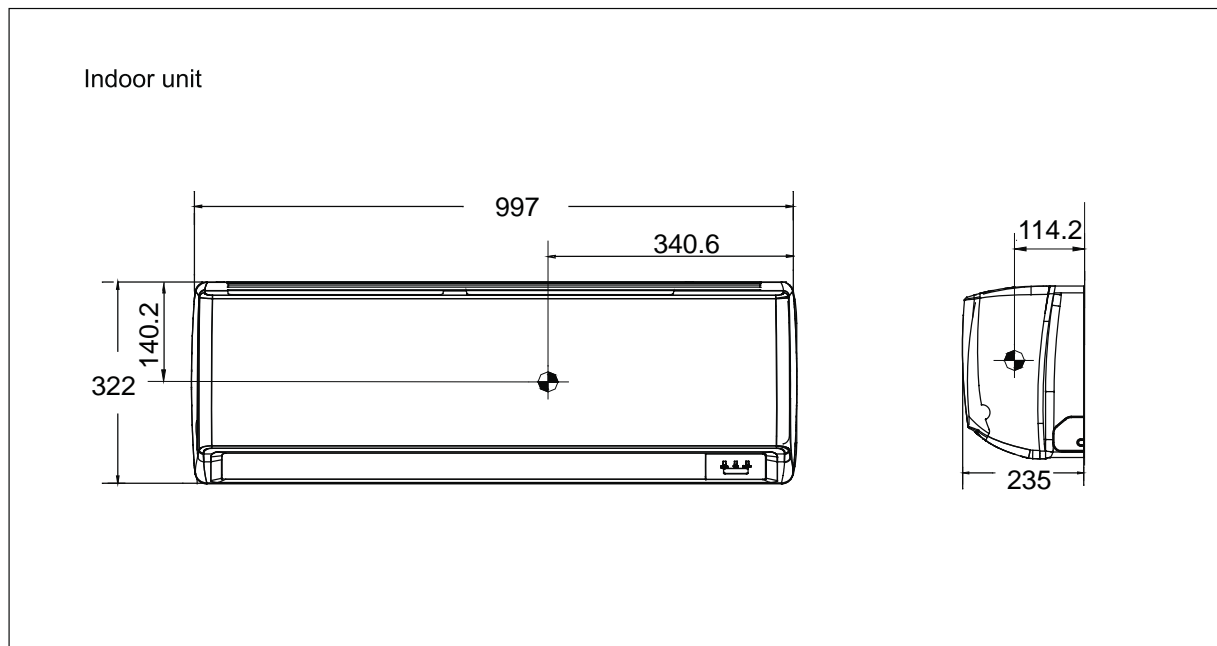

# 11 Service Diagnosis

## 11.1 Caution for Diagnosis

The operation lamp flashes when any of the following errors is detected.

1. When a protection device of the indoor or outdoor unit is activated or when the thermistor malfunctions, disabling equipment operation.
2. When a signal transmission error occurs between the indoor and outdoor units. In either case, conduct the diagnostic procedure described in the following pages.

## 11.2 Parameter of primary electronic appliance

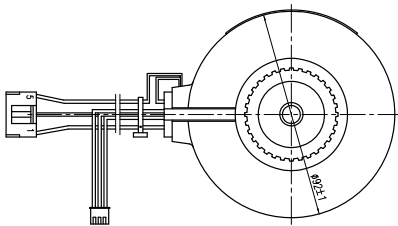
NO	Name	Parameter	Picture
1	Fan motor	Rated voltage: DC310V Rated current: 0.17A Rated frequency: – Resistance: 548Ω	

## 11.3 Problem Symptoms and Measures

Symptom	Check Item	Details of Measure
None of the units operates	Check the power supply.	Check to make sure that the rated voltage is supplied.
	Check the indoor PCB.	Check to make sure that the indoor PCB is broken.
Operation sometimes stops	Check the power supply.	A power failure of 2 to 10 cycles can stop air conditioner operation.
Equipment operates but does not cool, or does not heat (only for heat pump)	Check for faulty operation of the electronic expansion valve.	Set the units to cooling operation, and compare the temperatures of the liquid side connection pipes of the connection section among rooms to check the opening and closing operation of the electronic expansion valves of the individual units.
	Diagnosis by service port pressure and operating current.	Check for insufficient gas.
Large operating noise and vibrations	Check the installation condition.	Check to make sure that the required spaces for installation (specified in the Technical Guide, etc.) are provided.

## 11.4 Error Codes and Description indoor display

	Code indication		fault description	Reference Page
	Indoor displaying panel code indication	Outdoor (LED1 flash times)		
Indoor and Outdoor	E7	15	Communication fault between indoor and outdoor units	Page .45
Indoor Malfunction	E1	--	Room temperature sensor failure	Page .36
	E2	--	Heat-exchange sensor failure	Page .36
	E4	--	Indoor EEPROM error	Page .37
	E14	--	Indoor fan motor malfunction	Page .38
Outdoor Malfunction	F12	1	Outdoor EEPROM error	Page .37
	F1	2	The protection of IPM	Page .41
	F22	3	Overcurrent protection of AC electricity for the outdoor model	Page .42
	F3	4	Communication fault between the IPM and outdoor PCB	Page.43
	F19	6	Power voltage is too high or low	Page .44
	F4	8	Overheat protection for Discharge temperature	Page .45
	F8	9	Outdoor DC fan motor fault	Page .40
	F21	10	Defrost temperature sensor failure	Page .36
	F7	11	Suction temperature sensor failure	Page .36
	F6	12	Ambient temperature sensor failure	Page .36
	F25	13	Discharge temperature sensor failure	Page .36
	F11	18	deviate from the normal for the compressor	Page .48
	F28	19	Loop of the station detect error	Page .48
	F2	24	Overcurrent of the compressor	Page .42
	F23	25	Overcurrent protection for single-phase of the compressor	Page .42
	E9	21	High work-intense protection	Page .49

### 11.4.1 Thermistor or Related Abnormality

Indoor display	E1: Room temperature sensor failure E2: Heat-exchange sensor failure
	LED1 flash 10 times: Defrost temperature sensor failure
Outdoor display	LED1 flash 11 times: Suction temperature sensor failure LED1 flash 12 times: Ambient temperature sensor failure LED1 flash 13 times: Discharge temperature sensor failure

Method of malfunction section	The temperatures detected by the thermistors are used to determine thermistor errors
Malfunction detection conditions	when the thermistor input is more than 4.92V or less than 0.08V during compressor operation.  ● Note: The values vary slightly in some models
*Thermistor resistance check	<ul style="list-style-type: none"> <li>■ Faulty connector connection</li> <li>■ Faulty thermistor</li> <li>■ Faulty PCB</li> </ul>
Troubleshooting	* Caution Be sure to turn off power switch before connect or disconnect connector, or else parts damage may be occurred.

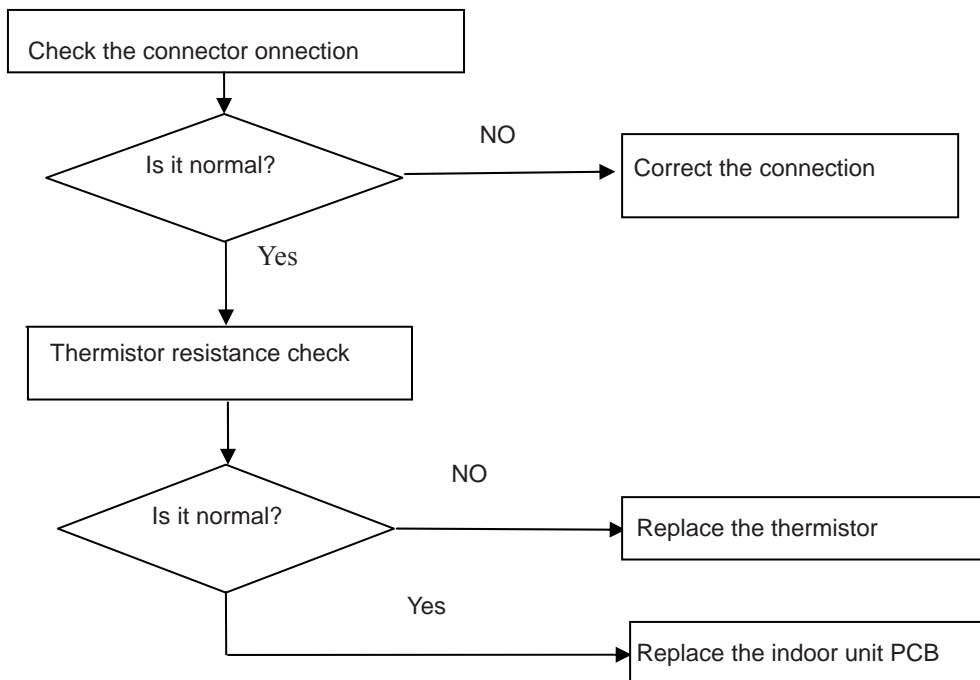

Thermistor resistance check method:

Remove the connector of the thermistor on the PCB, and measure the resistance of thermistor using tester. The relationship between normal temperature and resistance is shown in the value of indoor thermistor.

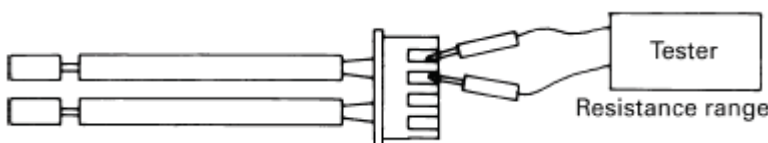

## 11.4.2 EEPROM abnormal

Indoor Display      E4: indoor EEPROM error  
 outdoor display    F12: Outdoor EEPROM error; Outdoor LED1 flash 1 times

Method of  
malfunction  
detection

The Data detected by the EEPROM are used to determine MCU

Malfunction  
detection  
conditions

when the data of EEPROM is error or the EEPROM is damaged

Supposed  
causes

- Faulty EEPROM data
- Faulty EEPROM
- Faulty PCB

Troubleshooting

\* Caution Be sure to turn off power switch before connect or disconnect connector, or parts damage may be occurred.

Replace the indoor or outdoor mainboard

### 11.4.3 Indoor fan motor malfunction

Indoor Display	E14
Method of Malfunction Detection	The rotation speed detected by the Hall IC during fan motor operation is used to determine abnormal fan motor operation
Malfunction Decision Conditions	when the detected rotation feedback signal don't received in 2 minutes
Supposed Causes	<ul style="list-style-type: none"> <li>■ Operation halt due to breaking of wire inside the fan motor .</li> <li>■ Fan motor overheat protection</li> <li>■ Operation halt due to breaking of the fan motor lead wires</li> <li>■ Detection error due to faulty indoor unit PCB</li> </ul>
Troubleshooting	<p>* Caution Be sure to turn off power switch before connect or disconnect connector, or else parts damage may be occurred.</p>

#### How to check Fan Motor (DC)

1. Check connector connection.
2. Check motor power supply voltage output (pins 1-4).
3. Check motor control voltage (pins 4-5).
4. Check rotation command voltage output (pins 4-6).
5. Check rotation pulse input (pins 4-7).

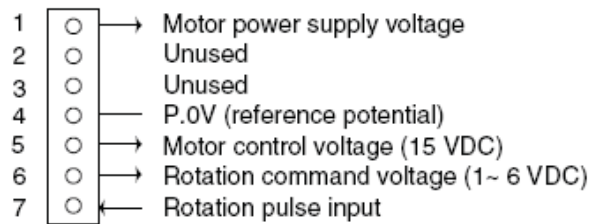

Notes: the a/c is electrifying, don't pull out or insert the terminals of the motor, else the motor would be damaged.



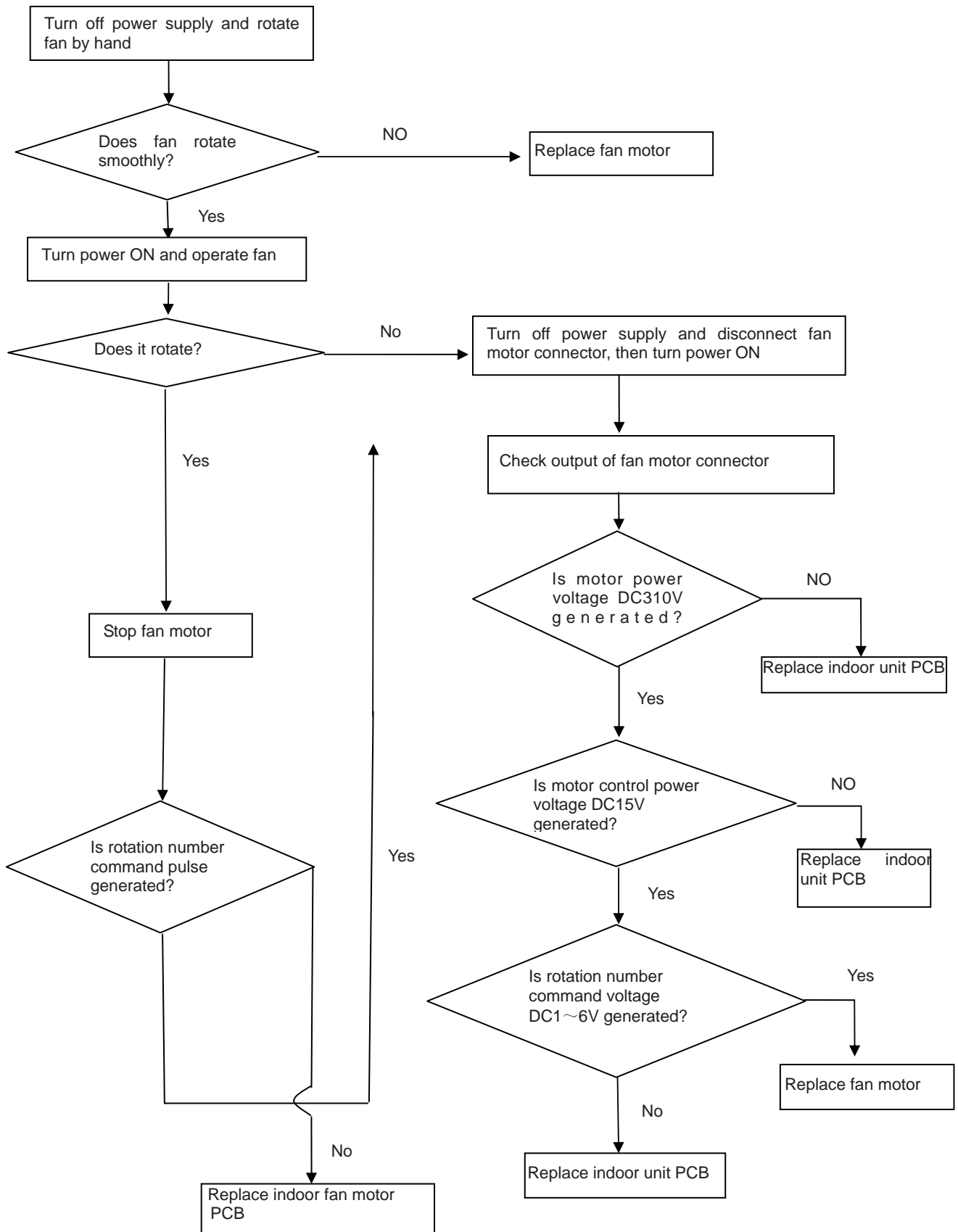

### 11.4.4 Outdoor DC fan motor fault

Outdoor display	LED1 flash 9 times
Method of malfunction detection	DC fan motor is detected by checking the fan running condition and so on
Malfunction detection conditions	when the data of EEPROM is error or the EEPROM is damaged
Supposed causes	<ul style="list-style-type: none"> <li>■DC fan motor protection dues to the DC fan motor faulty</li> <li>■DC fan motor protection dues to faulty PCB</li> </ul>
Troubleshooting	<p><b>* Caution</b></p> <p>Be sure to turn off power switch before connect or disconnect connector, or parts damage may be occurred.</p>

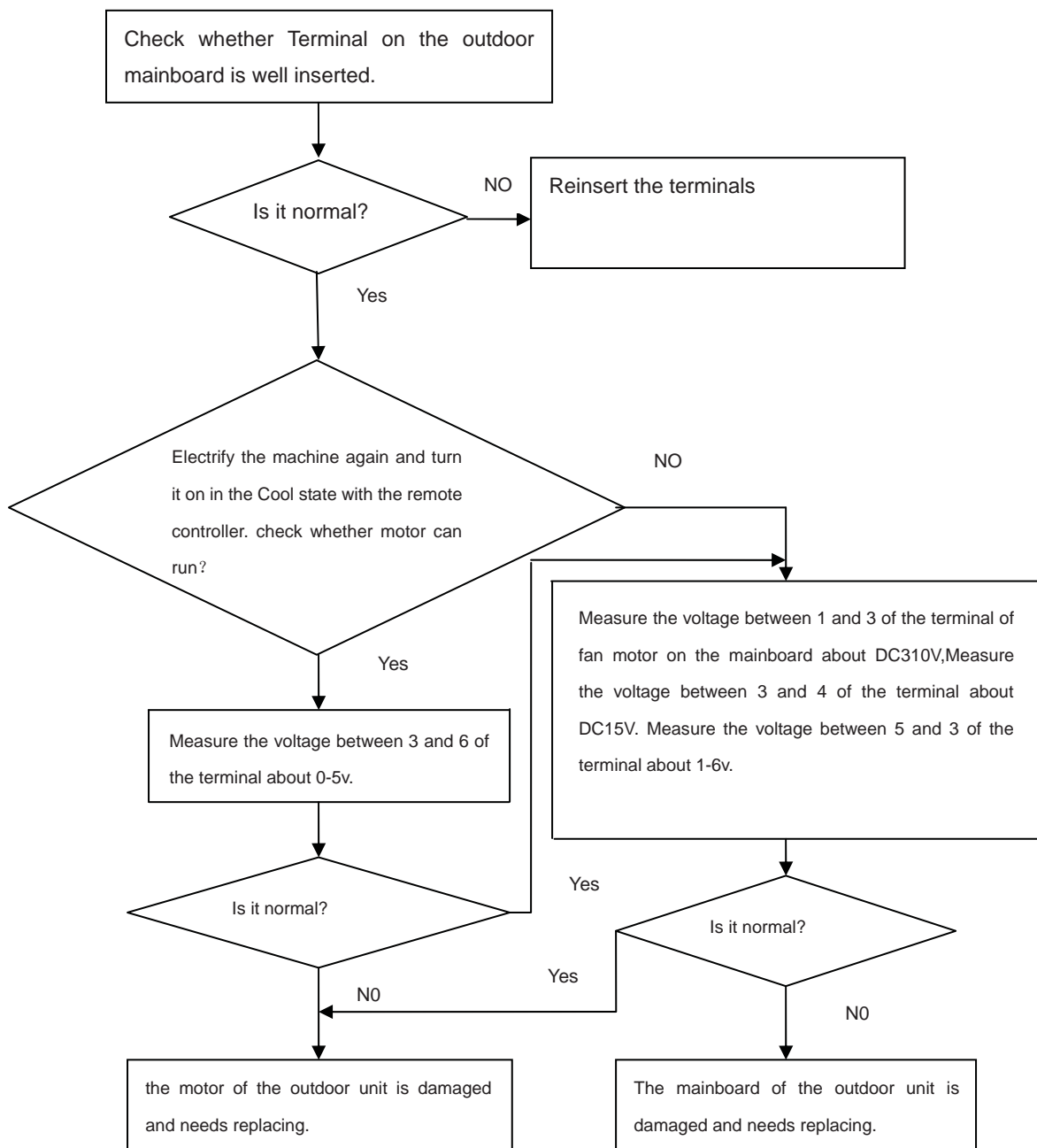

### 11.4.5 IPM protection

Outdoor display	LED1 flash 2 times
Method of malfunction detection	IPM protection is detected by checking the compressor running condition and so on
Malfunction detection conditions	<ul style="list-style-type: none"> <li>■The system leads to IPM protection due to over current</li> <li>■The compressor faulty leads to IPM protection</li> <li>■circuit component of IPM is broken and led to IPM protection</li> </ul>
Supposed causes	<ul style="list-style-type: none"> <li>■IPM protection dues to the compressor faulty</li> <li>■IPM protection dues to faulty PCB of IPM module</li> <li>■Compressor wiring disconnected</li> </ul>
Troubleshooting	<p><b>* Caution</b></p> <p>Be sure to turn off power switch before connect or disconnect connector, or else parts damage may be occurred..</p>

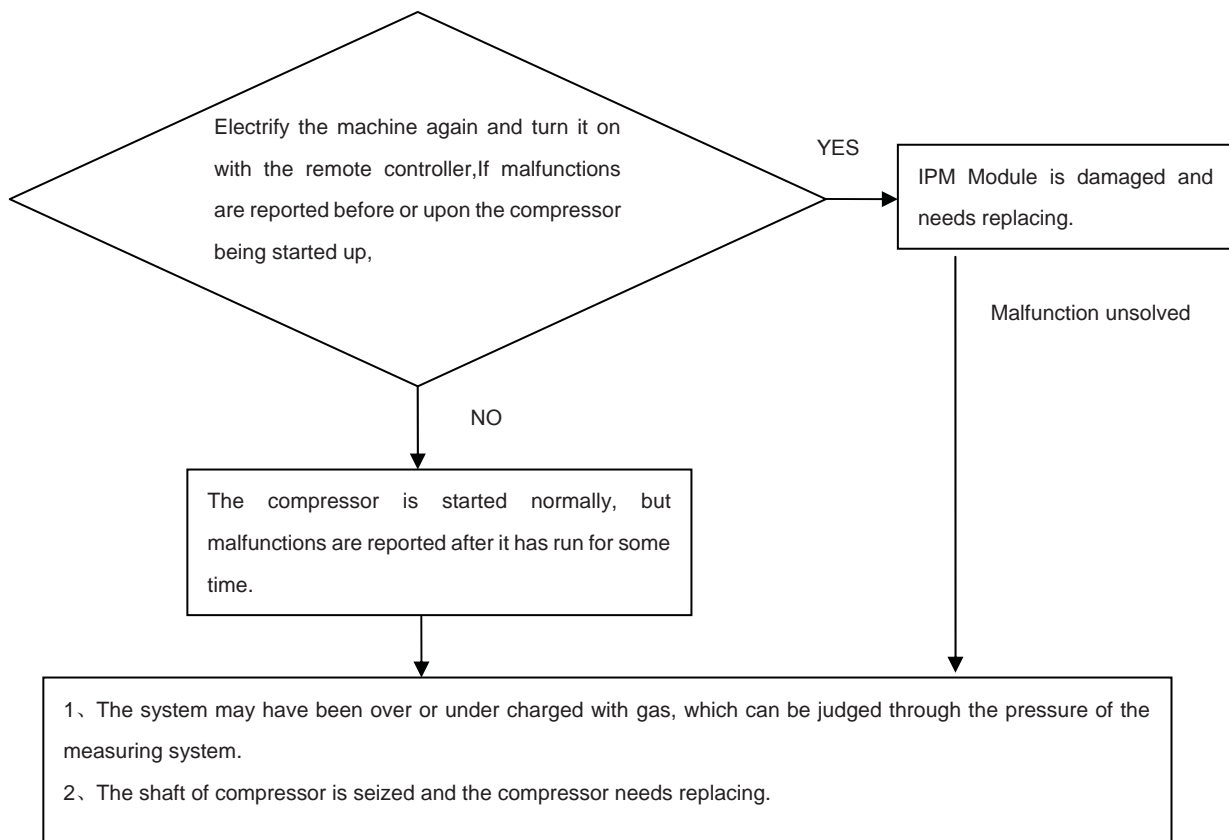

### 11.4.6 Over-current of the compressor

Outdoor display LED1 flash 3 or 24 or 25 times

Method of malfunction detection	the current of the compressor is too high
Malfunction detection conditions	when the IPM Module is damaged or the compressor is damaged. power supply voltage is too low or too high
Supposed causes	<ul style="list-style-type: none"> <li>■ Faulty IPM Module</li> <li>■ Faulty compressor</li> <li>■ Faulty power supply</li> </ul>
Troubleshooting	<p><b>* Caution</b></p> <p>Be sure to turn off power switch before connect or disconnect connector, or parts damage may be occurred...</p>

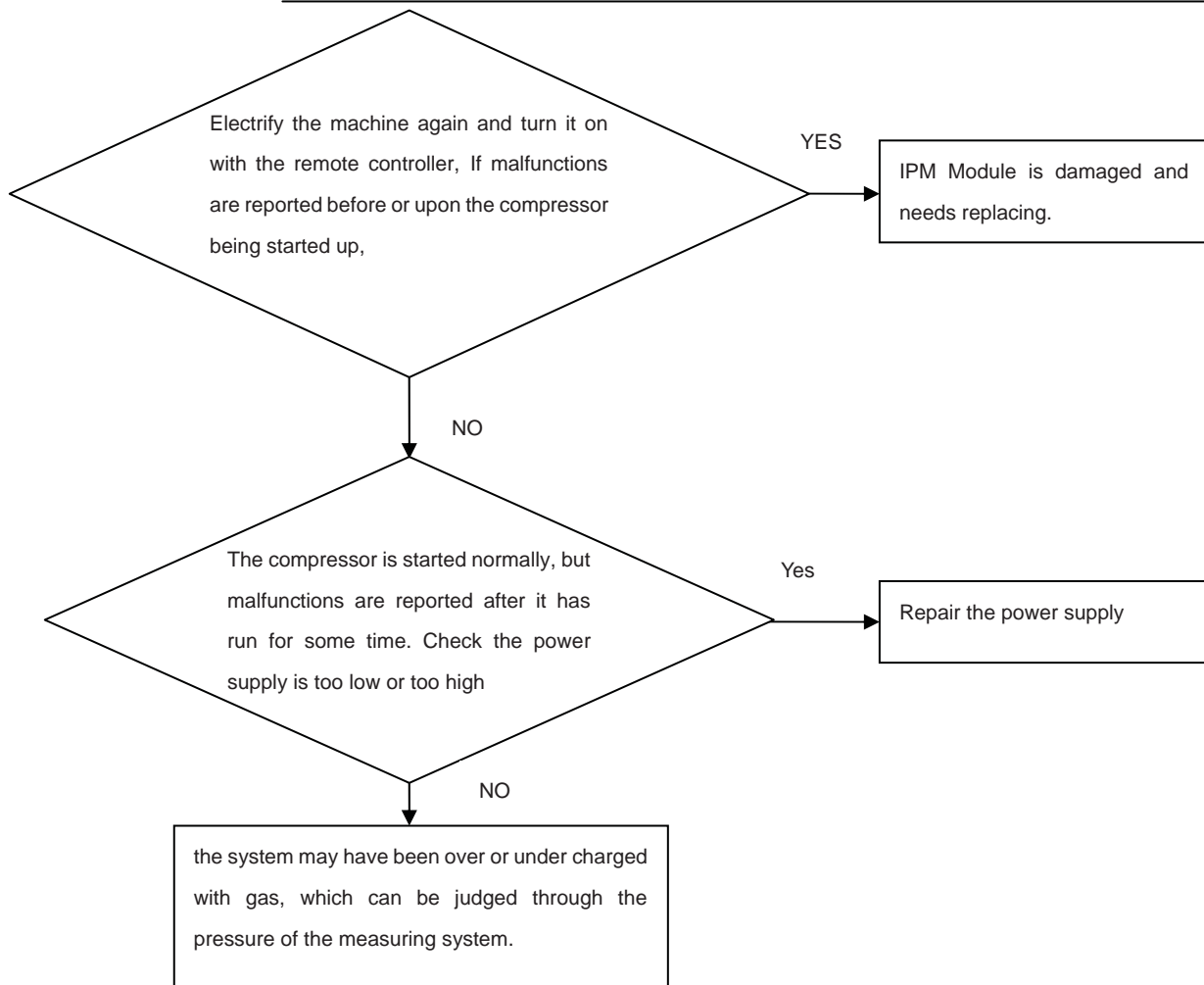

### 11.4.7 The communication fault between IPM and outdoor PCB

Outdoor display

LED1 flash 4 times

Method of malfunction detection	Communication is detected by checking the IPM module and the outdoor PCB
Malfunction detection conditions	<ul style="list-style-type: none"> <li>■The outdoor PCB broken leads to communication fault</li> <li>■The IPM module broken leads to communication fault</li> </ul>
Supposed causes	<ul style="list-style-type: none"> <li>■The outdoor PCB is broken</li> <li>■The IPM module is broken</li> <li>■Communication wiring disconnected</li> </ul>
Troubleshooting	<p><b>* Caution</b></p> <p>Be sure to turn off power switch before connect or disconnect connector, or else parts damage may be occurred</p>

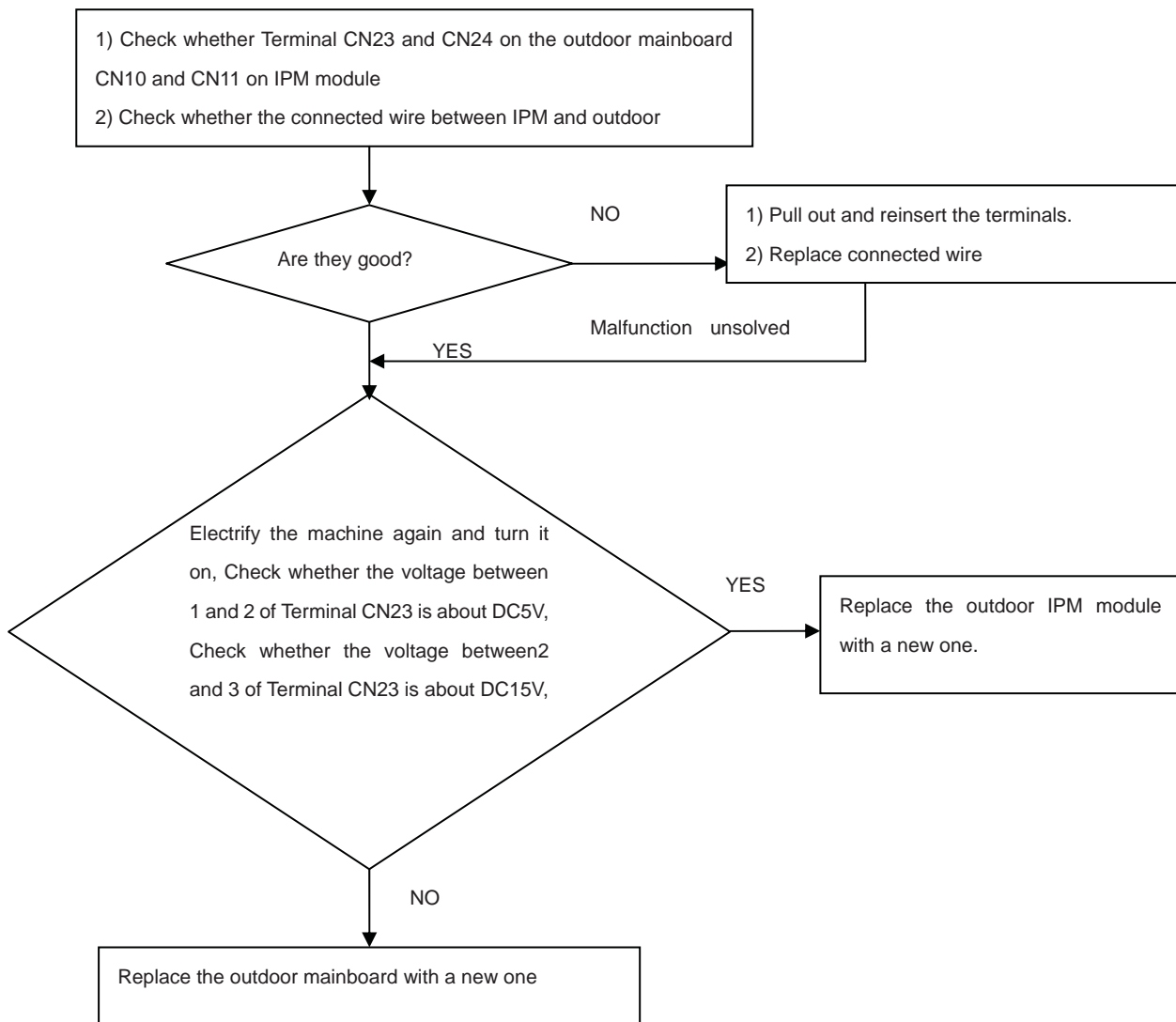

### 11.4.8 Power Supply Over or under voltage fault

Outdoor display

LED1 flash 6 times The power supply is over voltage

Method of malfunction detection	An abnormal voltage rise or fall is detected by checking the specified voltage detection
Malfunction detection conditions	An voltage signal is fed from the voltage detection circuit to the microcomputer
Supposed causes	<ul style="list-style-type: none"> <li>■ Supply voltage not as specified.</li> <li>■ The IPM module is broken.</li> <li>■ The outdoor PCB is broken.</li> </ul>
Troubleshooting	<p><b>* Caution</b></p> <p>Be sure to turn off power switch before connect or disconnect connector, or else parts damage may be occurred.</p>

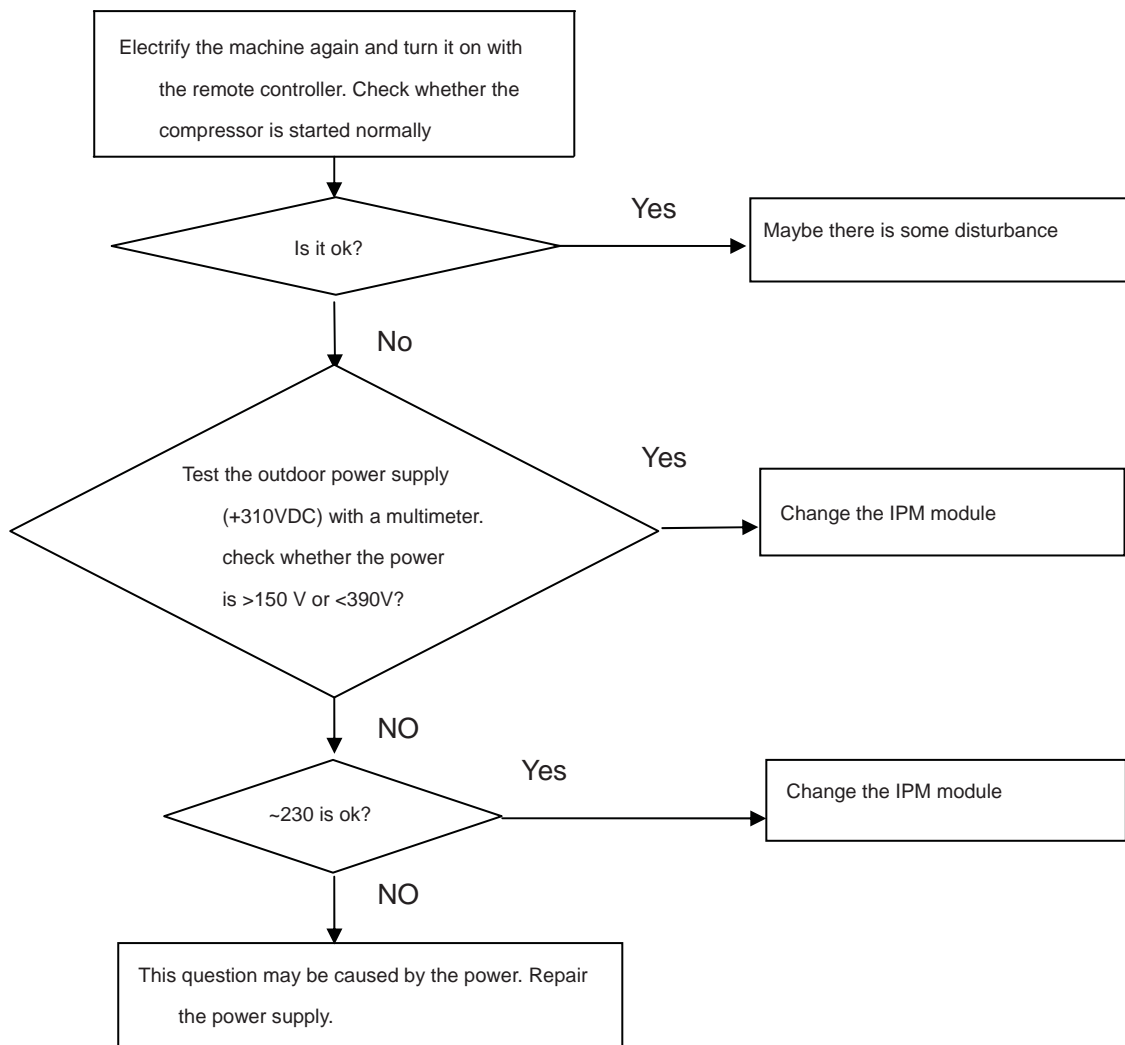

### 11.4.9 Overheat Protection For Discharge Temperature

Outdoor display

LED1 flash 8 times

Method of malfunction detection	The Discharge temperature control is checked with the temperature being detected by the Discharge pipe thermistor
Malfunction detection conditions	when the compressor discharge temperature is above 110°C
Supposed causes	<ul style="list-style-type: none"> <li>■ Electronic expansion valve defective</li> <li>■ Faulty thermistor</li> <li>■ Faulty PCB</li> </ul>
Troubleshooting	<p><b>* Caution</b></p> <p>Be sure to turn off power switch before connect or disconnect connector, or else parts damage may be occurred.</p>

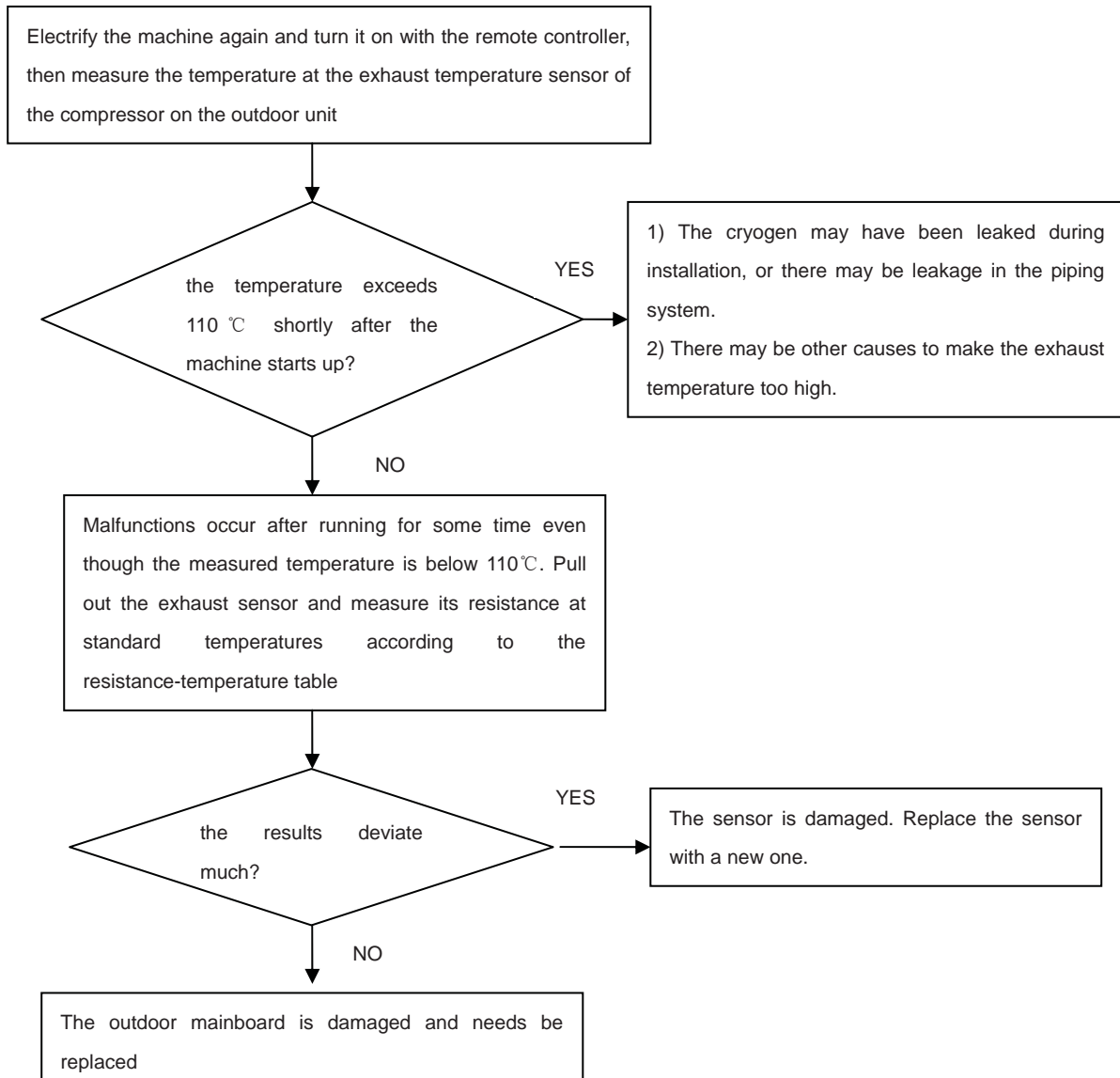

### 11.4.10 The communication fault between indoor and outdoor

indoor display: E7  
 Outdoor display: LED1 flash 15 times

Method of malfunction detection

Communication is detected by checking the indoor PCB and the outdoor PCB

Malfunction detection conditions

- The outdoor PCB broken leads to communication fault
- The indoor PCB broken leads to communication fault

Supposed causes

- Communication wiring disconnected
- The indoor PCB is broken
- The outdoor PCB is broken
- The module PCB is broken

Troubleshooting

**\* Caution**

Be sure to turn off power switch before connect or disconnect connector, or else parts damage may be occurred.

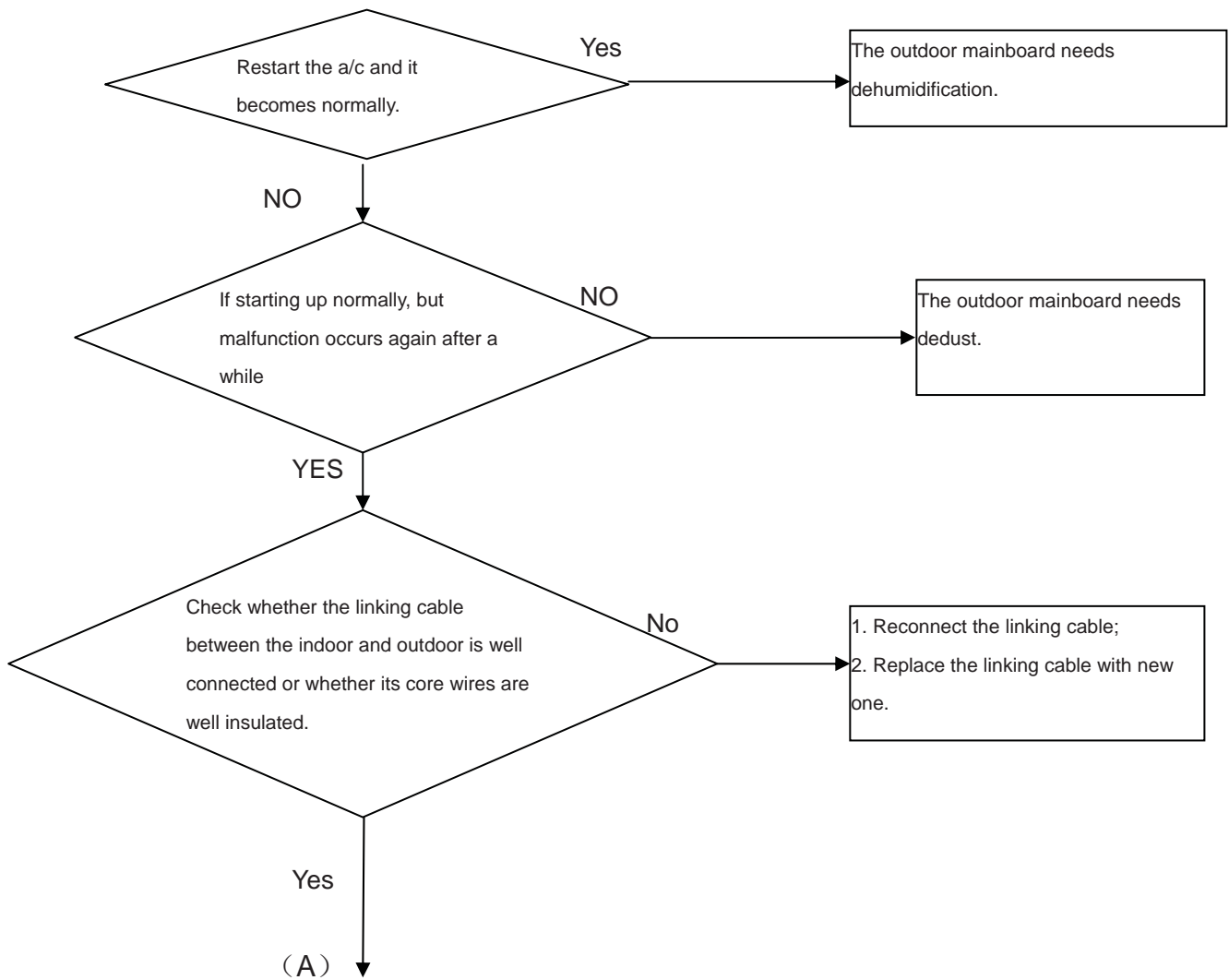



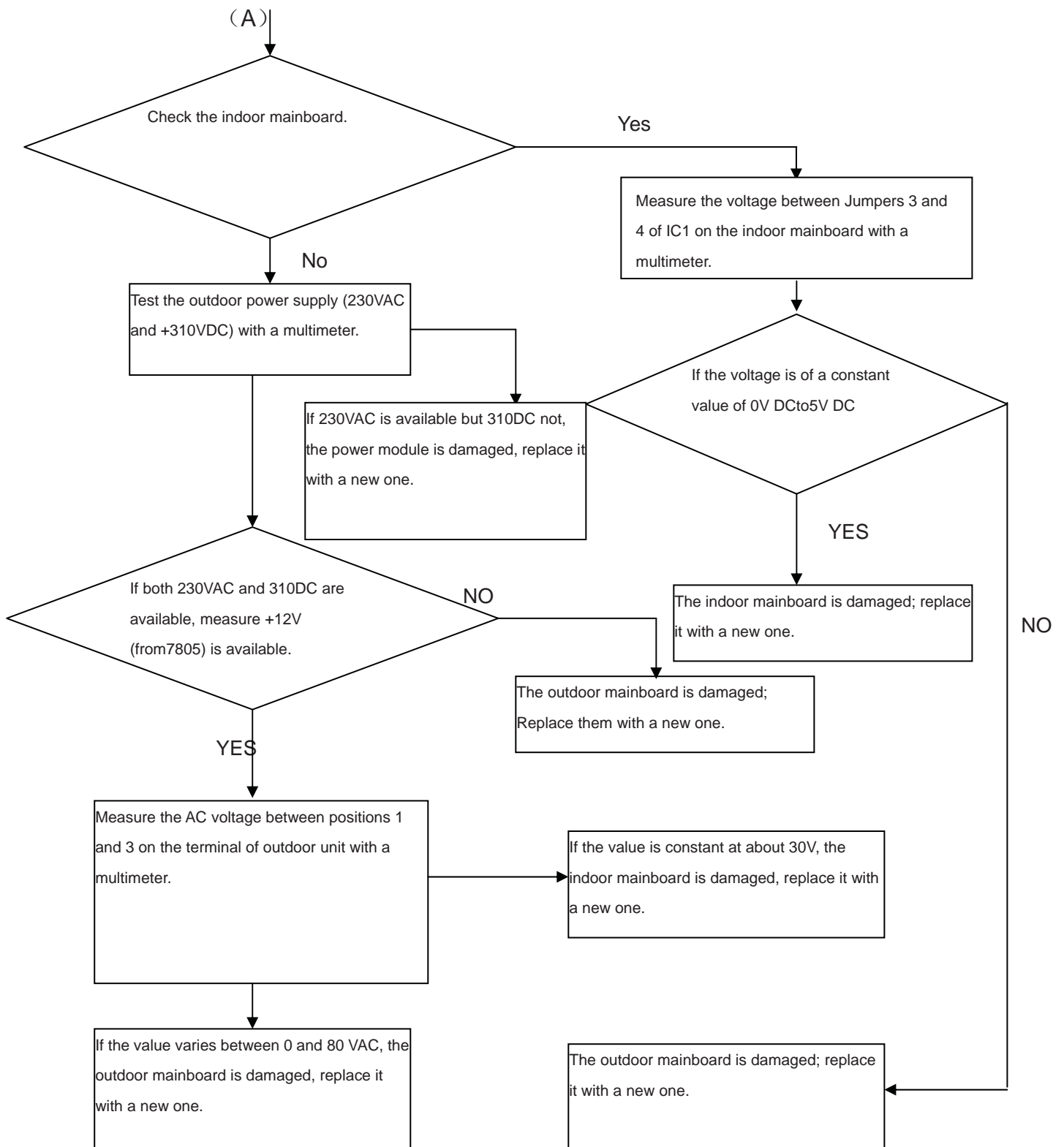

### 11.4.11 Loss of synchronism detection

#### Inverter side current detection is abnormal

Outdoor display      LED1 flash 18 times  
 LED1 flash 19 times

Method of malfunction detection	The position of the compressor rotor can not detected normally
Malfunction detection conditions	when the wiring of compressor is wrong or the connection is poor; or the compressor is damaged
Supposed causes	<ul style="list-style-type: none"> <li>■Faulty The wiring of compressor</li> <li>■Faulty compressor</li> <li>■Faulty PCB</li> </ul>
Troubleshooting	<p><b>* Caution</b></p> <p>Be sure to turn off power switch before connect or disconnect connector, or else parts damage may be occurred.</p>

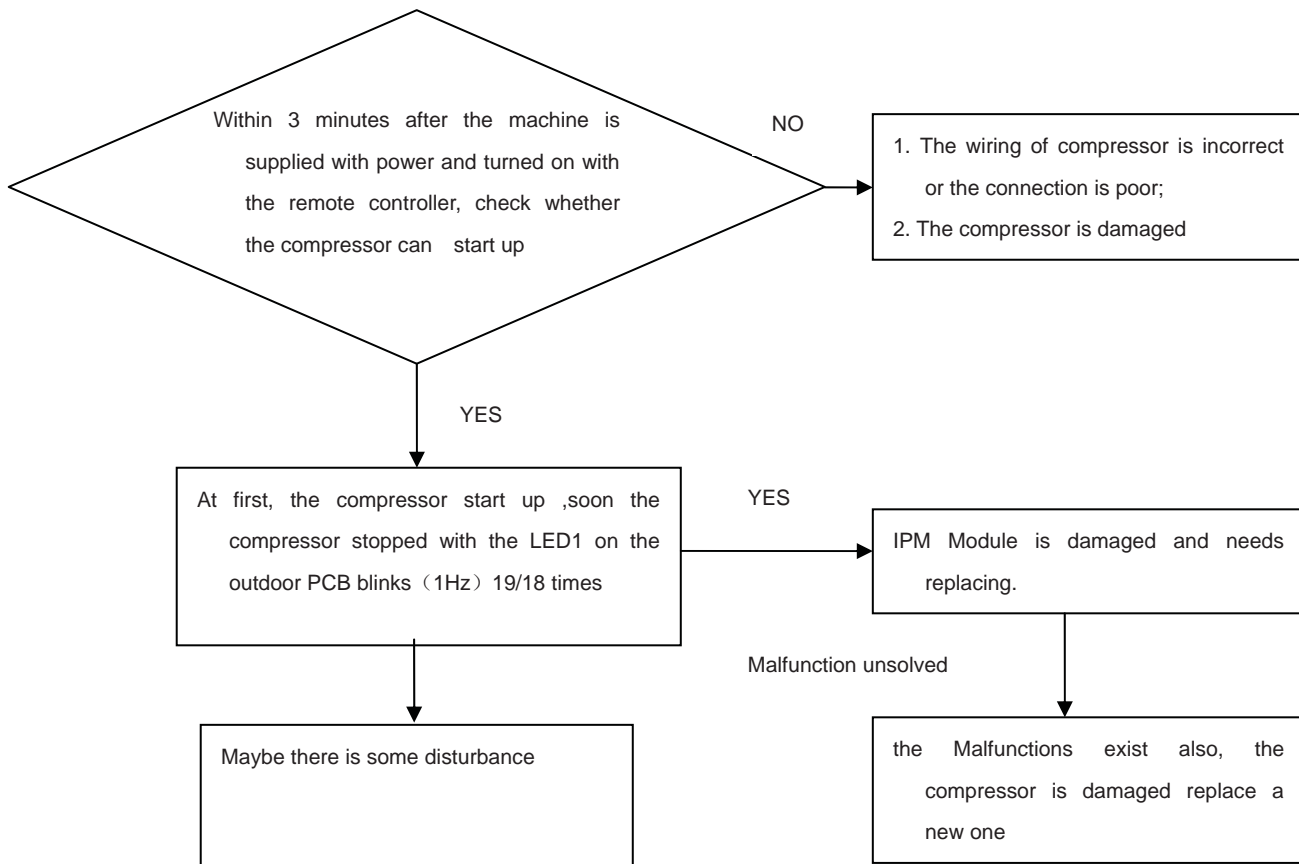

### 11.4.12 High work-intense protection

Outdoor display

LED1 flash 21 times

Method of malfunction detection	High work-intense control is activated in the heating mode if the temperature being sensed by the heat exchanger thermistor exceeds the limit.
Malfunction detection conditions	Activated when the temperature being sensed by the heat exchanger rises above 65°C twice in 30 minutes.
Supposed causes	<ul style="list-style-type: none"> <li>■ Faulty electronic expansion valve</li> <li>■ Dirty heat exchanger</li> <li>■ Faulty heat-exchange sensor</li> <li>■ Insufficient gas</li> </ul>
Troubleshooting	<p><b>* Caution</b></p> <p>Be sure to turn off power switch before connect or disconnect connector, or else parts damage may be occurred.</p>

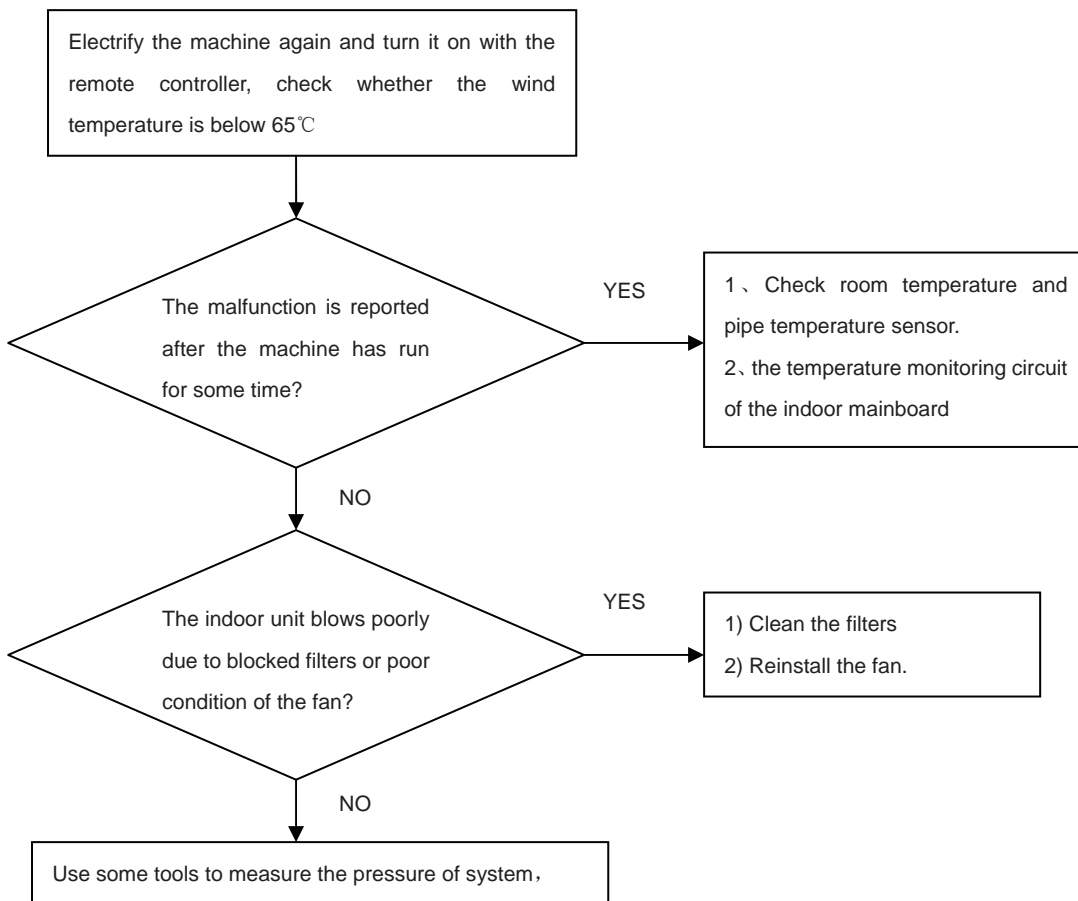

# 12. Circuit diagrams

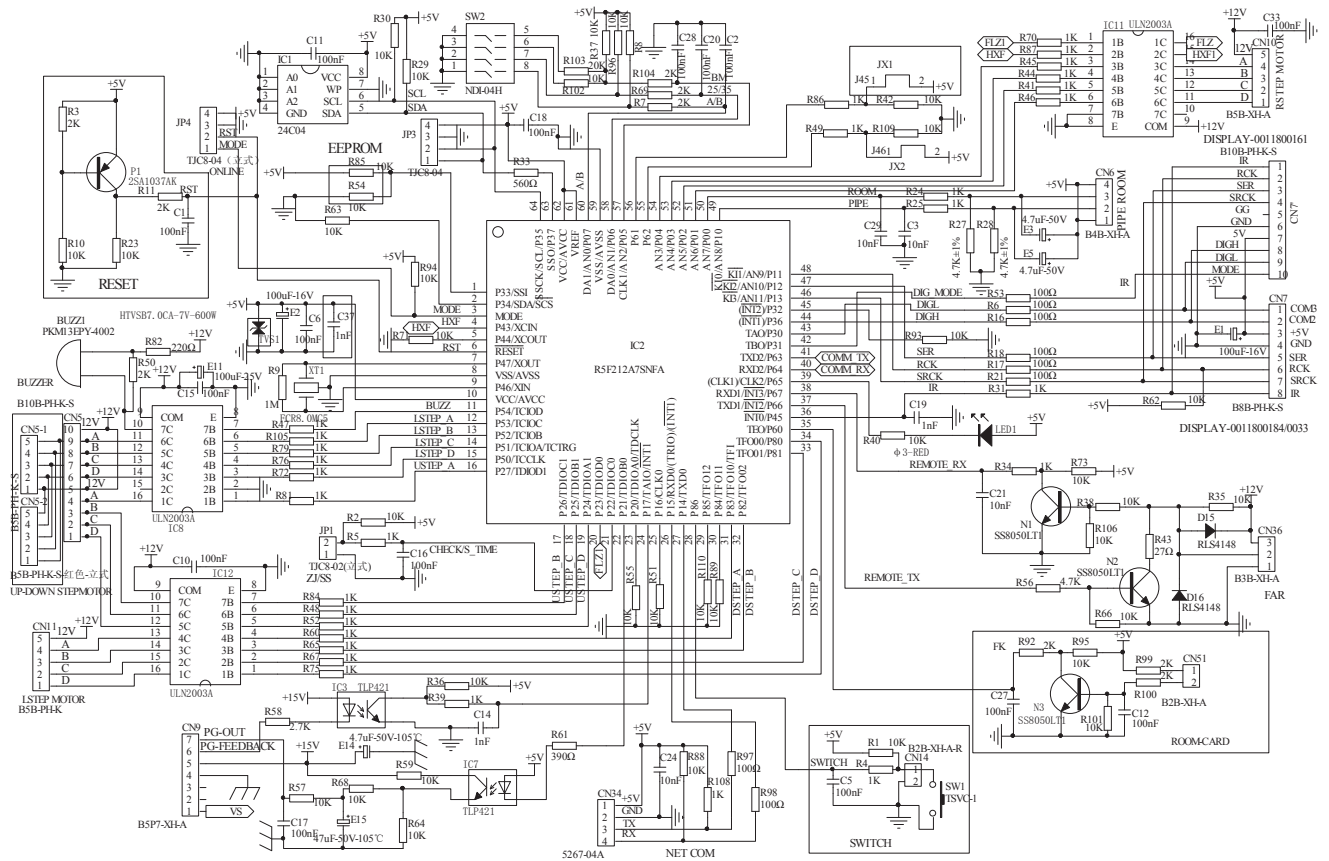

5267-04A

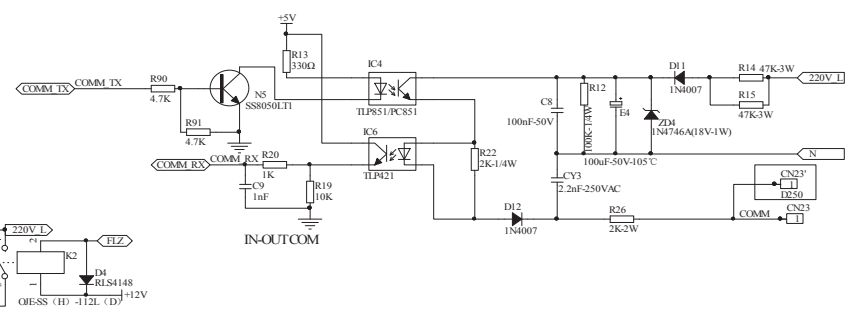
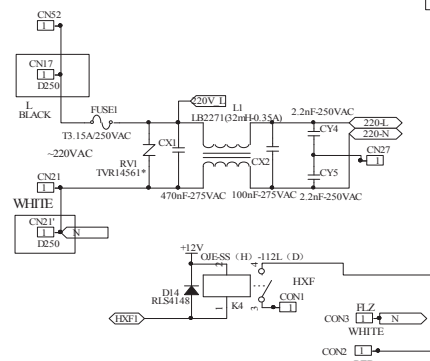
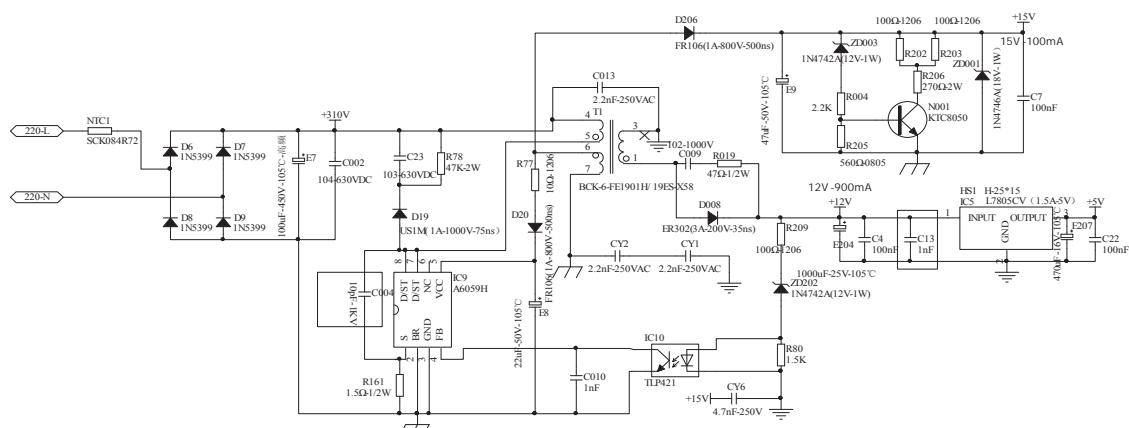

# Sincere Forever

## Haier Group

---

Haier Industrial Park, No.1, Haier Road

266101, Qingdao, China\_

Http: //www.haier.com

Edited by : Liu Yujuan

Yang Xiaodong

Signed by : Yang Wenjun

Approved by: He shiquan

# Haier

# REMOVAL PROCEDURE

## Wall Mounted Type DC Inverter FREE MATCH N-Series SERIES:50N



### **WARNING**

This service information is designed for experienced repair technicians only and is not designed for use by the general public. It does not contain warnings or cautions to advise non-technical individuals of potential dangers in attempting to service a product. Products powered by electricity should be serviced or repaired only by experienced professional technicians. Any attempt to service or Repair the product or products dealt with in this service information by anyone else could result in serious injury or death

2016 (Qingdao Haier Air Conditioner General corp. , Ltd)  
All rights reserved. Unauthorized copying and distribution is a violation of law

**Haier Group**

Version: V1

Date: 2016-01-14

# Removal of front panel Indoor unit

Procedure



Warning

Be sure to wait 10 minutes or more after turning off all power supplies before disassembling work.

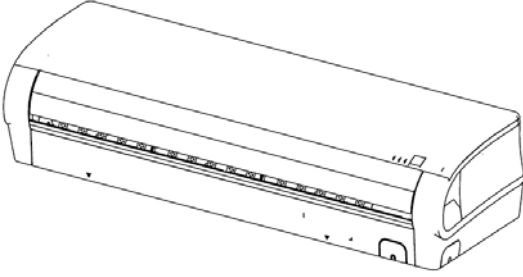
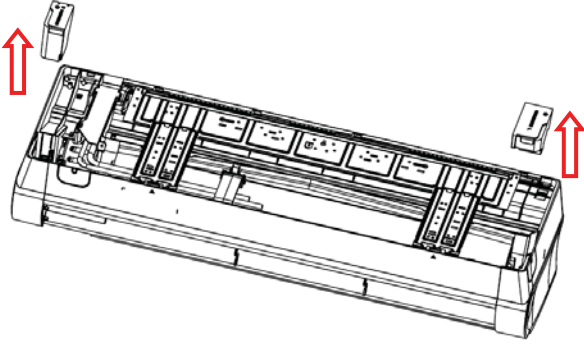
Step		Procedure	Points
1.Features			
			
2.Remove the front panel			
1	Remove the foam cushion		

Procedure



Warning

Be sure to wait 10 minutes or more after turning off all power supplies before disassembling work.

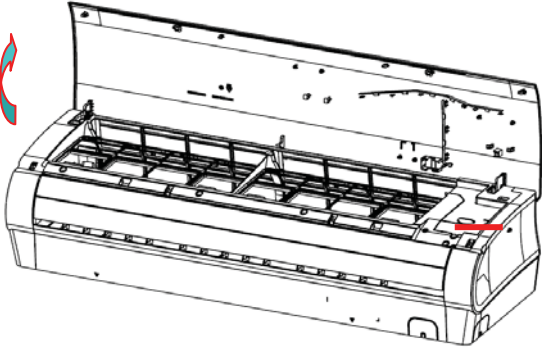
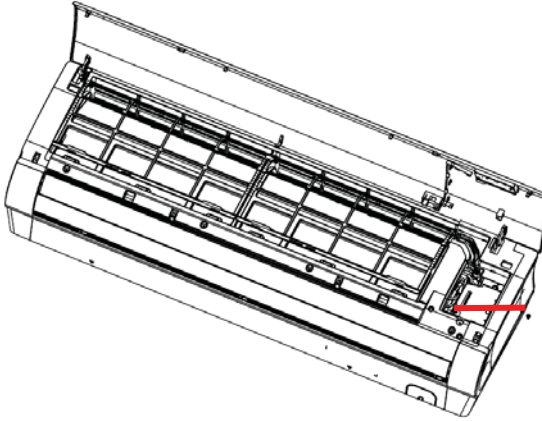
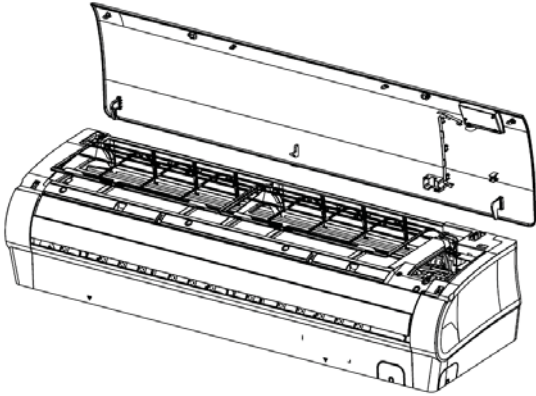
Step		Procedure	Points
2	<p>Hold the front panel by the tabs on the both sides and lift it until it stops with a click. Loosen the screw and lift up the casing cover</p>		
3	<p>Loosen the screw and lift up the control box cover</p>		
4	<p>Pull the wires out of the control box and then release the pivots on both sides of the unit to remove the front panel.</p>		



Remove the air filters and horizontal flap

Procedure



Warning Be sure to wait 10 minutes or more after turning off all power supplies before disassembling work.

Step		Procedure	Points
1	Lift an air filter upwards slightly and then pull it out downwards		
Remove the horizontal flap			
1	Release the side of pivot and then Release the Center of the pivot. Bend the horizontal blade slightly and remove it.		<p>■ The horizontal flap is Double</p>

Remove the casing

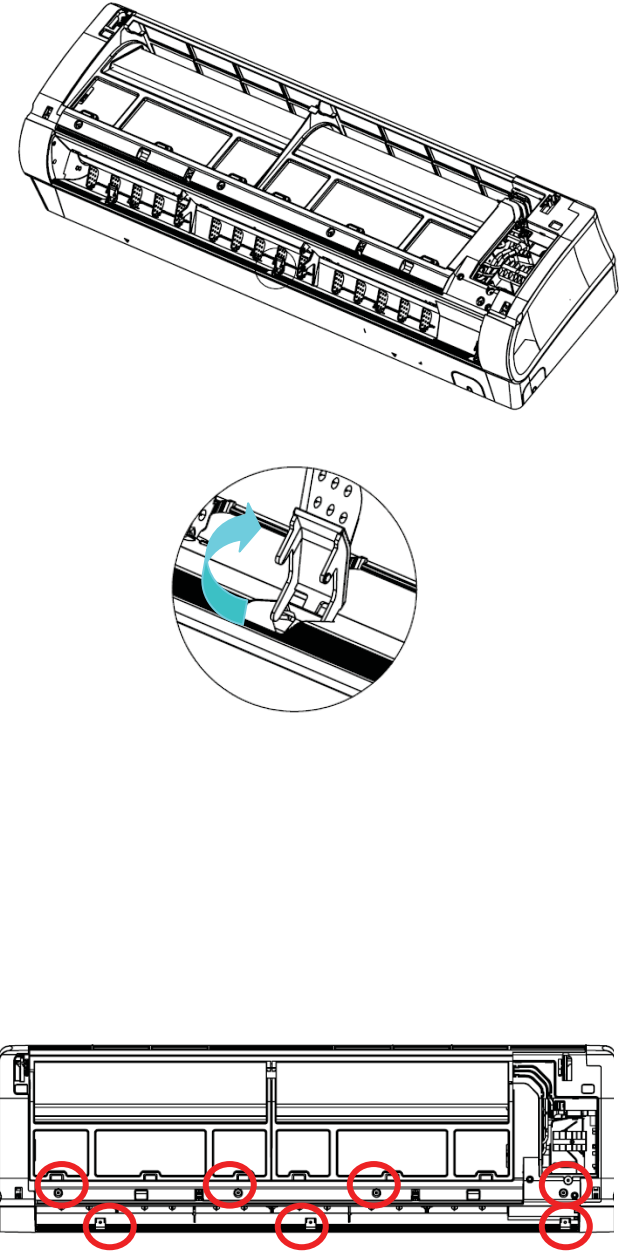
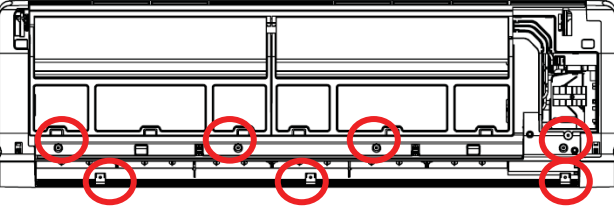
Step		Procedure	Points
1	Release the screw covers(3EA)		
2	Loosen the marked Screw (7EA)		

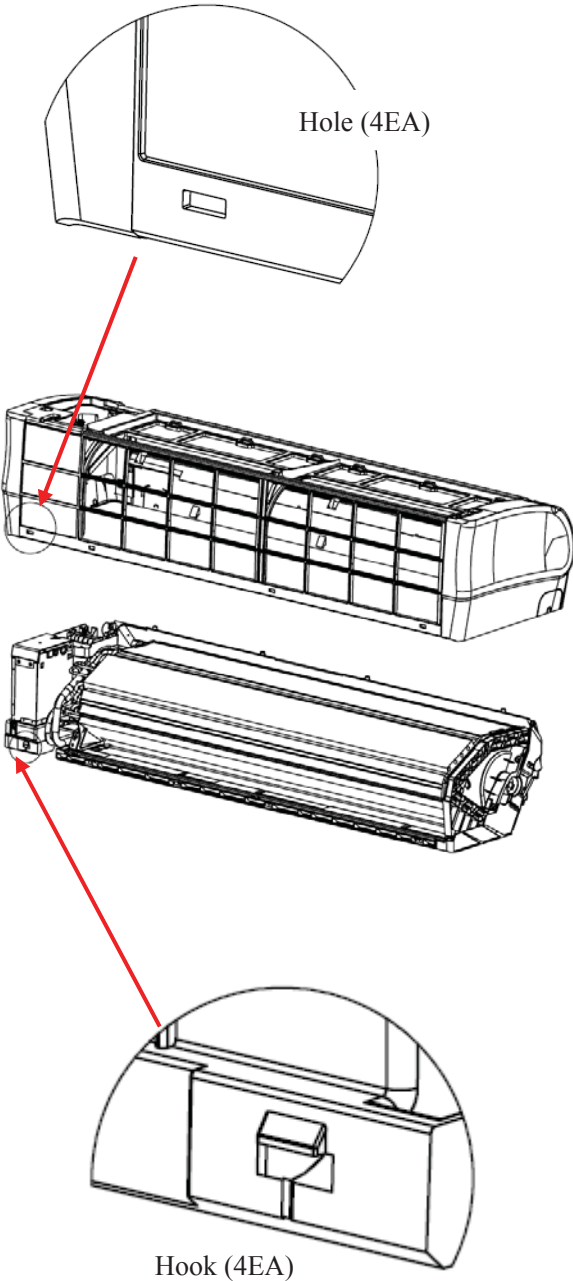
Step		Procedure	Points
3	<p>Release the marked hooks (4EA) and then Pull the front grille out Horizontally and remove it</p>		<ul style="list-style-type: none"> <li>■ When assembling, install the front grille horizontally so as not to stuff the flap inside.</li> <li>■ When assembling, make sure the four hooks are caught properly.</li> </ul>

Release stepping motor and control box

Procedure



Warning Be sure to wait 10 minutes or more after turning off all power supplies before disassembling work.

Step		Procedure	Points
1	Loosen the stepping motor screws (4EA) and then Release the stepping motor		
2	Loosen the control Box screws (2EA) And then pull it.		

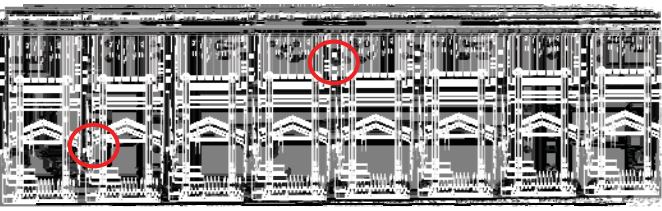
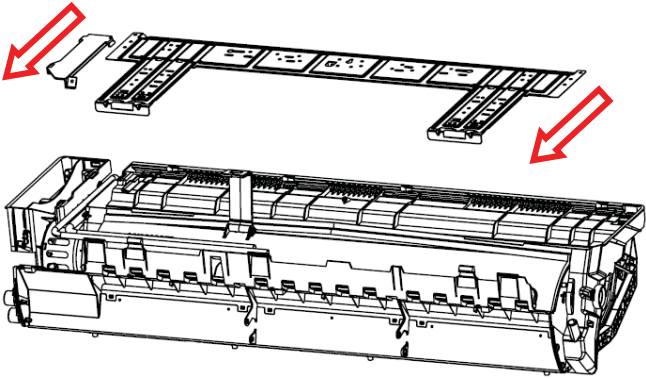
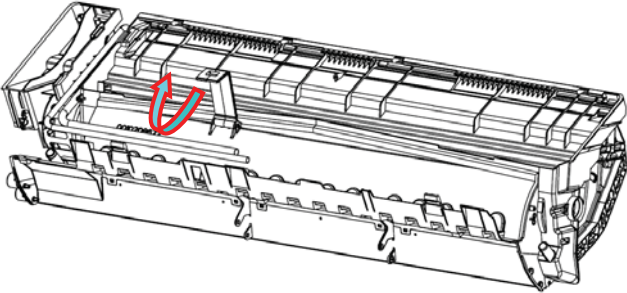

Removal of Heat Exchanger

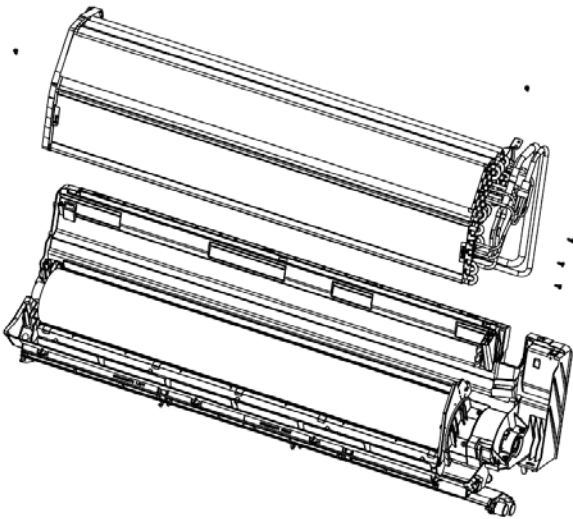
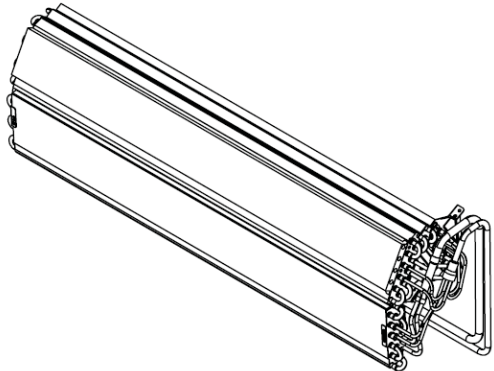
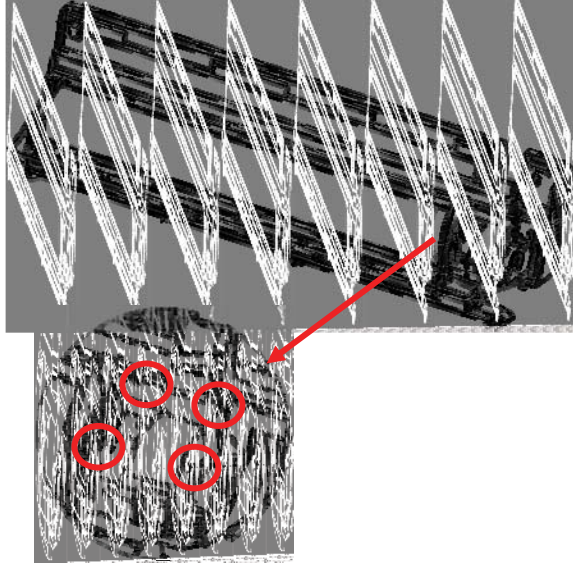
Step		Procedure	Points
1	Loosen the marked screws(2EA)		
2	Pull mounting plate and heat exchanger bracket and then release them.		
3	Release the fixture plate from the base frame hook and remove it.		

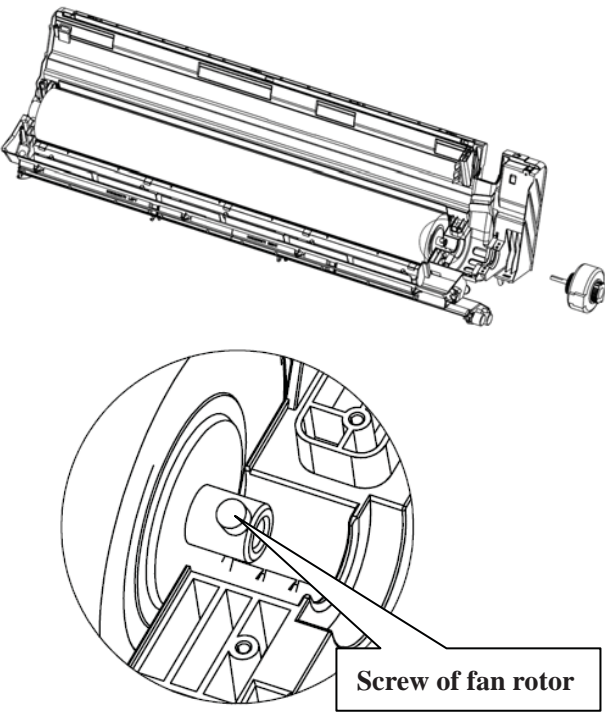
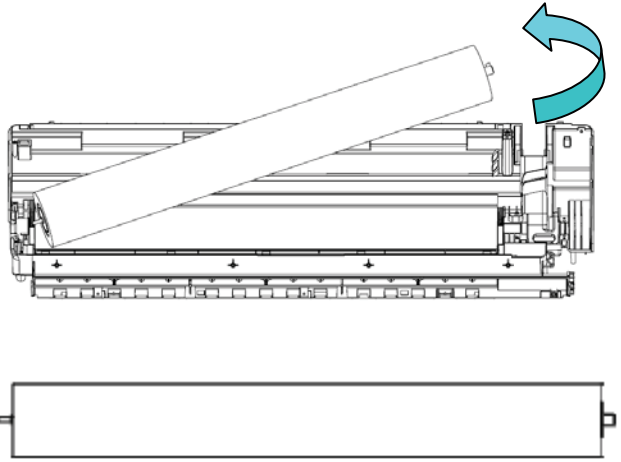
Step		Procedure	Points
4	Loosen the marked screws (7EA)		
5	Remove the heat exchanger		
Remove Fan rotor			
1	Loosen the marked screws(4EA) and release the cover of fan motor		

Step		Procedure	Points
2	Loosen the marked screw (1EA) and remove fan motor		
3	Lift up the right part of the fan and remove it		

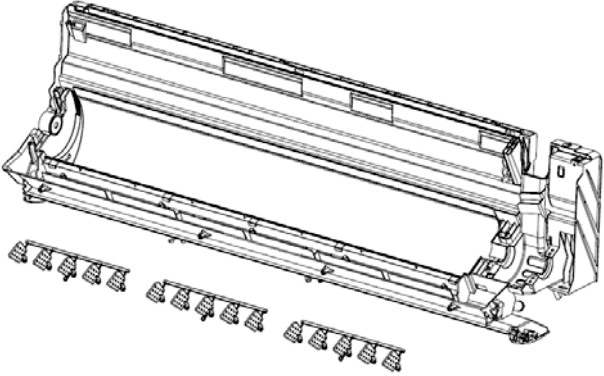
Remove horizontal louver and fan motor bracket

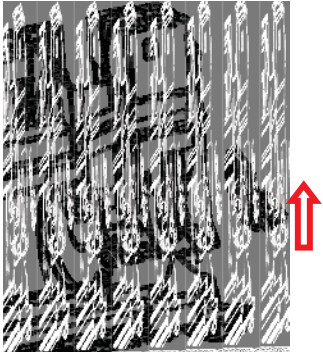
Step		Procedure	Points
1	Every blade go round and round, then move it		
Remove fan motor bracket			
1	Pull the hook of fan motor bracket and upward remove it	 	



Step		Procedure	Points
1	Pull the hook of bearing bracket and upward remove it	