

## ZASTOSOWANIE

Wentylator przeznaczony do wszelkiego rodzaju instalacji wentylacji ogólnej. Typowe zastosowania to:

- wentylacja mieszkań, biur, sklepów,
- wentylacja barów, kawiarni, restauracji.

## KONSTRUKCJA

- obudowa z galwanizowanej blachy stalowej,
- wirnik z łopatkami pochylonymi do przodu z galwanizowanej blachy stalowej, wyważony dynamicznie zgodnie z normą ISO 1940,
- puszka przyłączeniowa na przewodzie (dł. 800 mm),
- możliwość montażu w dowolnej pozycji.

## SILNIK ELEKTRYCZNY

- silniki jednofazowe 230/400V, 50Hz,
- silniki trójfazowe 400V, 50Hz,
- stopień ochrony IP55, klasa izolacji F,
- do regulacji napięciowej (silniki jednofazowe),
- do regulacji częstotliwościowej (silniki trójfazowe),
- termiczne zabezpieczenie uzwojenia przed przeciążeniem.



WWW



DTR



CE

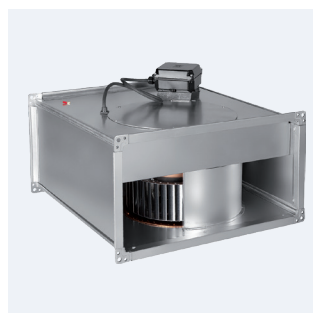

Wersja do stref zagrożenia wybuchem - ILT EX

## DANE TECHNICZNE

Typ	prędkość obrotowa	pobór mocy max	natężenie max 230V   400V		wydajność max	poziom ciśn. akust.*	temp. pracy min   max		masa	regulator		ErP	nr artykułu
	[obr/min]	[W]	[A]	[A]	[m³/h]	[dB(A)]	[°C]	[kg]	230V	400V			
<b>4 BIEGUNY-JEDNOFAZOWE</b>													
ILB/4-200	1240	240	1,15	-	1090	57	-40	+70	15	TLR 15, RVS-1,5	-	2018	41020010
ILB/4-225	1130	520	2,45	-	1670	56	-40	+70	20	REB 5, RVS-3	-	2018	41020030
ILB/4-250	1130	950	4,4	-	2350	60	-40	+70	25	REB 5, RVS-5	-	2018	41020070
<b>6 BIEGUNÓW-JEDNOFAZOWE</b>													
ILB/6-225	800	200	1	-	1080	48	-40	+70	20	TLR 15, RVS-1,5	-	2018	41020050
ILB/6-250	800	310	1,5	-	1500	49	-40	+70	25	REB 2,5, RVS-3	-	2018	41020090
ILB/6-285	825	660	3,2	-	2650	55	-40	+70	32	REB 5, RVS-3	-	2018	41020120
ILB/6-315	810	710	3,4	-	2780	57	-40	+70	40	REB 5, RVS-5	-	2018	41020150
ILB/6-355	800	1300	6,3	-	4070	60	-40	+70	60	REB 10, RVS-7	-	2018	41020170
<b>4 BIEGUNY-TRÓJFAZOWE</b>													
ILT/4-200	1270	260	1	0,6	1150	59	-40	+70	15	-	RMT-1,5, Falownik 0.4kW	2018	41020020
ILT/4-225	1160	500	1,7	1	1700	58	-40	+70	20	-	RMT-1,5, Falownik 0.4kW	2018	41020040
ILT/4-250	1170	930	3	1,8	2650	62	-40	+70	25	-	RMT-2,5, Falownik 0.75kW	2018	41020080
ILT/4-285	1070	1260	4,2	2,4	3100	61	-40	+70	32	-	RMT-5, Falownik 1.5kW	2018	41020110
ILT/4-315	1390	2440	8	4,6	4160	68	-40	+70	42	-	RMT-8, Falownik 2.2kW	2018	41020140
ILT/4-355	1330	5690		9,1	7760	70	-20	+60	65	-	RMT-12, Falownik 5.5kW	2018	41020145
ILT/4-400	1350	6350		9,3	7765	69	-20	+60	80	-	RMT-12, Falownik 7.5kW	2018	41020195
ILT/4-450	1360	8360		14,6	8940	66	-20	+60	100	-	Falownik 7.5kW	2018	41020215
<b>6 BIEGUNÓW-TRÓJFAZOWE</b>													
ILT/6-225	840	220	1	0,6	1185	50	-40	+70	20	-	RMT-1,5, Falownik 0.4kW	2018	41020060
ILT/6-250	800	280	1	0,6	1630	51	-40	+70	25	-	RMT-1,5, Falownik 0.4kW	2018	41020100
ILT/6-285	840	670	2,3	1,3	2700	56	-40	+70	32	-	RMT-2,5, Falownik 0.75kW	2018	41020130
ILT/6-315	900	710	2,5	1,4	2820	57	-40	+70	40	-	RMT-2,5, Falownik 0.75kW	2018	41020160
ILT/6-355	875	1380	5,2	3	4200	61	-40	+70	65	-	RMT-5, Falownik 1.5kW	2018	41020180
ILT/6-400	950	3000	11	6,4	7400	66	-20	+60	80	-	RMT-8, Falownik 4.0kW	2018	41020200
ILT/6-450	900	5350	17,3	10	10850	67	-20	+60	100	-	Falownik 5.5kW	2018	41020220
<b>8 BIEGUNÓW-TRÓJFAZOWE</b>													
ILT/8-355	660	614	2,4	1,4	3030	52	-40	+70	65	-	RMT-2,5, Falownik 0.75kW	2018	41020190
ILT/8-400	700	1340	6,4	3,7	5350	59	-20	+70	80	-	RMT-5, Falownik 1.5kW	2018	41020210
ILT/8-450	675	2380	7,7	4,5	8000	61	-20	+70	100	-	RMT-8, Falownik 2.2kW	2018	41020230

\* mierzony w odległości 1m od wentylatora. Wentylator umieszczony w kanale.

## CHARAKTERYSTYKI PRACY I CHARAKTERYSTYKI AKUSTYCZNE

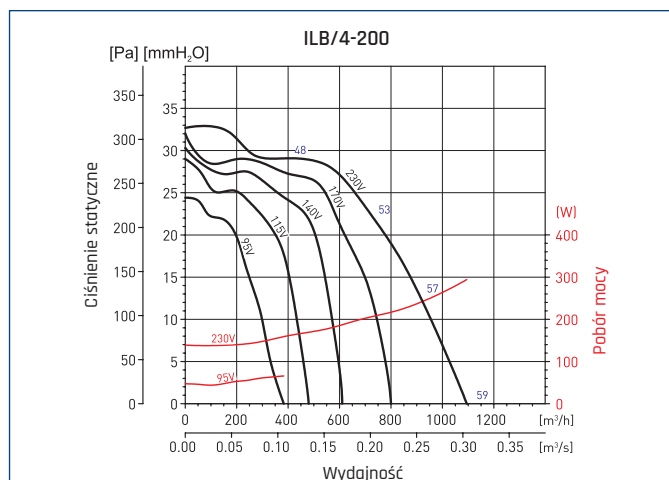

Częstotliwość Hz/dB(A)		63	125	250	500	1000	2000	4000	8000
Wlot	A	50	61	65	70	71	67	62	54
	B	50	61	65	70	71	67	62	54
	C	46	57	61	66	67	63	58	50
	D	41	52	56	61	62	58	53	45
Wylot	A	46	61	64	70	76	72	70	63
	B	46	61	64	70	76	72	70	63
	C	43	58	61	67	73	69	67	60
	D	39	54	57	63	69	65	63	56
Emitowany	A	50	54	56	58	63	63	58	48
	B	49	53	55	57	62	62	57	47
	C	46	50	52	54	59	59	54	44
	D	41	45	47	49	54	54	49	39

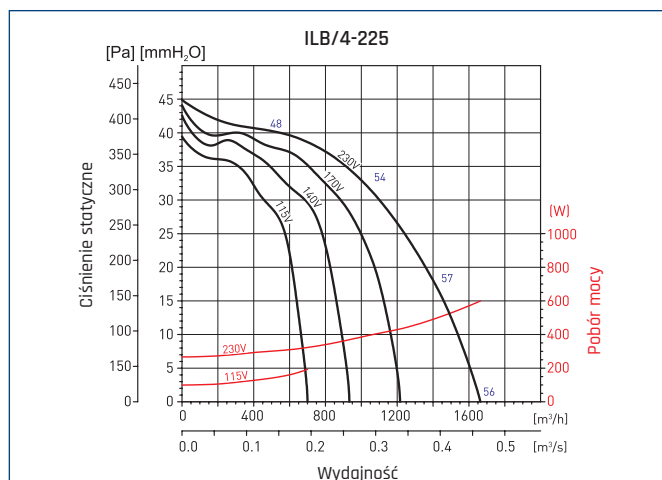

Częstotliwość Hz/dB(A)		63	125	250	500	1000	2000	4000	8000
Wlot	A	51	63	66	71	72	69	64	55
	B	52	64	67	72	73	70	65	56
	C	49	61	64	69	70	67	62	53
	D	45	57	60	65	66	63	58	49
Wylot	A	47	62	65	71	76	73	71	64
	B	48	63	66	72	77	74	72	65
	C	46	61	64	70	75	72	70	63
	D	42	57	60	66	71	68	66	59
Emitowany	A	51	56	57	59	62	62	57	47
	B	52	57	58	60	63	63	58	48
	C	49	54	55	57	60	60	55	45
	D	44	49	50	52	55	55	50	40

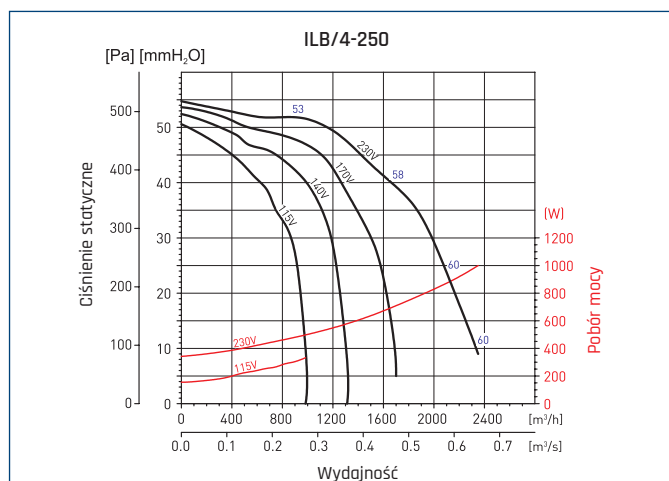

Częstotliwość Hz/dB(A)		63	125	250	500	1000	2000	4000	8000
Wlot	A	55	67	69	74	75	74	69	60
	B	55	67	69	74	75	74	69	60
	C	53	65	67	72	73	72	67	58
	D	49	61	63	68	69	68	63	54
Wylot	A	51	66	68	76	79	78	75	68
	B	52	67	69	77	80	79	76	69
	C	50	65	67	75	78	77	74	67
	D	46	61	63	71	74	73	70	63
Emitowany	A	56	61	61	64	65	64	60	51
	B	56	61	61	64	65	64	60	51
	C	54	59	59	62	63	62	58	49
	D	49	54	54	57	58	57	53	44

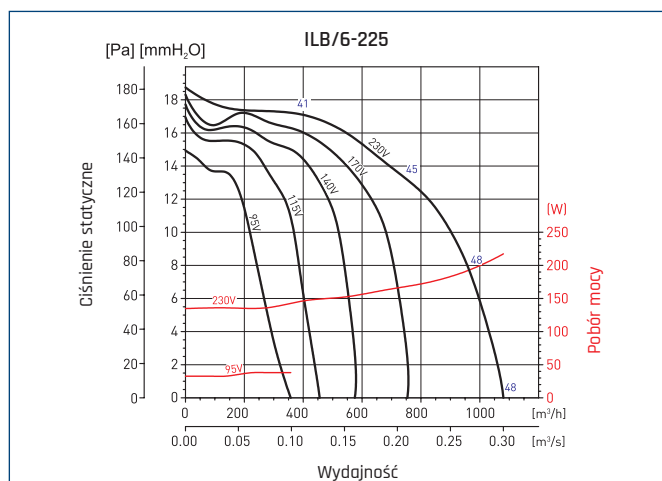

Częstotliwość Hz/dB(A)		63	125	250	500	1000	2000	4000	8000
Wlot	A	46	54	57	62	63	60	55	43
	B	47	55	58	63	64	61	56	44
	C	44	52	55	60	61	58	53	41
	D	39	47	50	55	56	53	49	36
Wylot	A	40	53	56	62	67	64	62	53
	B	41	54	57	63	68	65	63	54
	C	38	51	54	60	65	62	60	51
	D	34	47	50	56	61	58	56	47
Emitowany	A	46	47	48	50	53	53	48	35
	B	46	47	48	50	53	53	48	35
	C	43	44	45	47	50	50	45	32
	D	39	40	41	43	46	46	41	28

## CHARAKTERYSTYKI PRACY I CHARAKTERYSTYKI AKUSTYCZNE

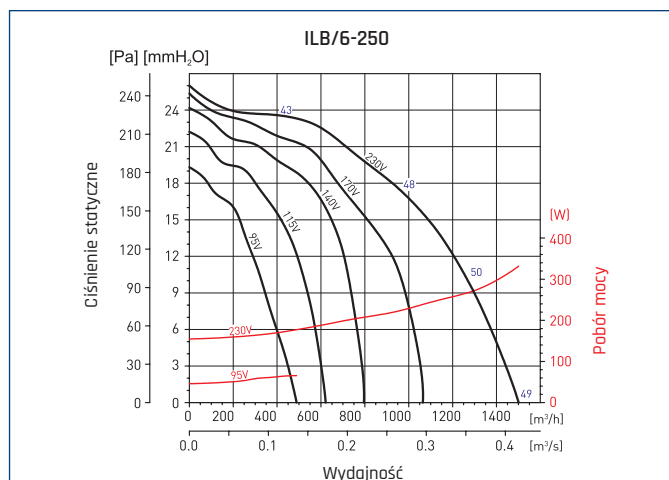

Częstotliwość Hz/dB(A)		63	125	250	500	1000	2000	4000	8000
Wlot	A	49	57	59	64	65	64	59	47
	B	50	58	60	65	66	65	60	48
	C	47	55	57	62	63	62	57	45
	D	43	51	53	58	59	58	53	41
Wylot	A	43	56	58	66	69	68	65	56
	B	44	57	59	67	70	69	66	57
	C	42	55	57	65	68	67	64	55
	D	38	51	53	61	64	63	60	51
Emitowany	A	49	50	50	53	53	53	49	37
	B	50	51	51	54	54	54	50	38
	C	48	49	49	52	52	52	48	36
	D	43	44	44	47	47	47	43	31

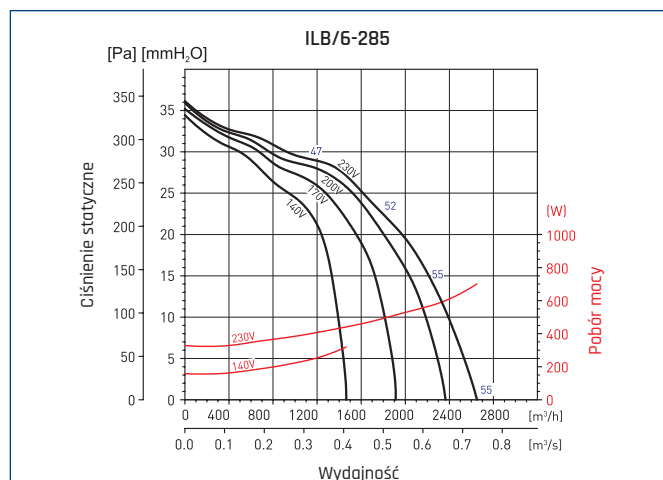

Częstotliwość Hz/dB(A)		63	125	250	500	1000	2000	4000	8000
Wlot	A	54	64	66	70	71	71	67	60
	B	54	64	66	70	71	71	67	60
	C	51	61	63	67	68	68	64	57
	D	46	56	58	62	63	63	59	52
Wylot	A	50	63	65	74	76	75	72	63
	B	50	63	65	74	76	75	72	63
	C	47	60	62	71	73	72	69	60
	D	43	56	58	67	69	68	65	56
Emitowany	A	54	58	59	60	56	56	54	49
	B	54	58	59	60	56	56	54	49
	C	51	55	56	57	53	53	51	46
	D	46	50	51	52	48	48	46	41

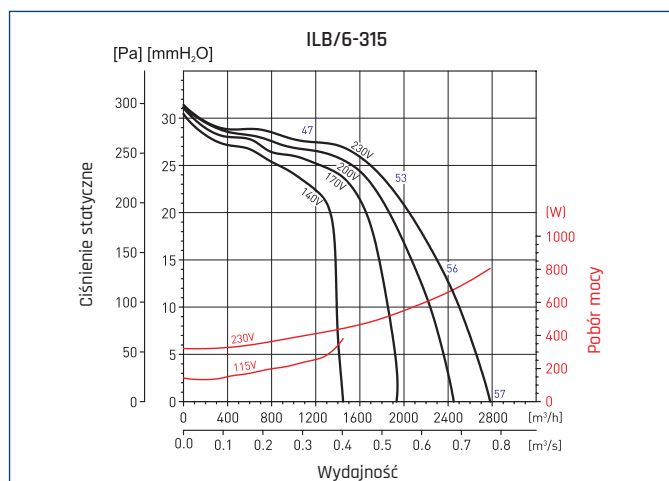

Częstotliwość Hz/dB(A)		63	125	250	500	1000	2000	4000	8000
Wlot	A	56	66	68	72	73	73	69	62
	B	55	65	67	71	72	72	68	61
	C	52	62	64	68	69	69	65	58
	D	52	62	64	68	69	69	65	58
Wylot	A	52	65	67	76	78	77	74	65
	B	51	64	66	75	77	76	73	64
	C	48	61	63	72	74	73	70	61
	D	44	57	59	68	70	69	66	57
Emitowany	A	56	60	61	62	58	56	56	51
	B	55	59	60	61	57	57	55	50
	C	52	56	57	58	54	54	52	47
	D	47	51	52	53	49	49	47	42

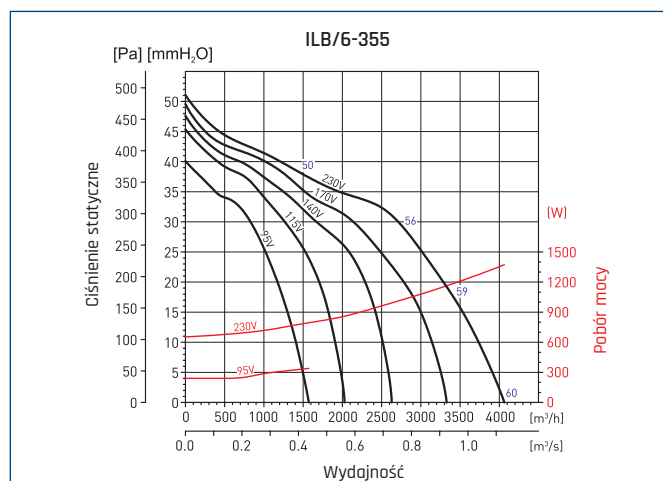

Częstotliwość Hz/dB(A)		63	125	250	500	1000	2000	4000	8000
Wlot	A	60	69	72	76	77	77	73	67
	B	59	68	71	75	76	76	72	66
	C	56	65	68	72	73	73	69	63
	D	50	59	62	66	67	67	63	57
Wylot	A	58	70	73	81	83	82	79	71
	B	57	69	72	80	82	81	78	70
	C	54	66	69	77	79	78	75	67
	D	49	61	64	72	74	73	70	62
Emitowany	A	58	63	65	64	61	60	58	55
	B	57	62	64	63	60	59	57	54
	C	54	59	61	60	57	56	54	51
	D	48	53	55	54	51	50	48	45

## CHARAKTERYSTYKI PRACY I CHARAKTERYSTYKI AKUSTYCZNE

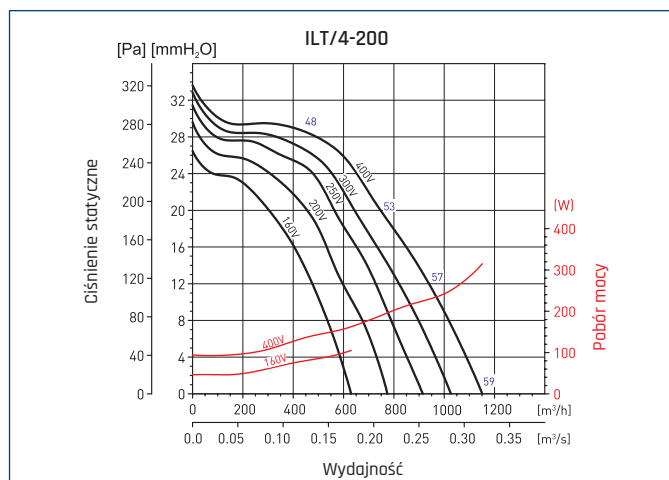

Częstotliwość Hz/dB(A)		63	125	250	500	1000	2000	4000	8000
Wlot	A	52	63	67	72	73	69	64	56
	B	50	61	65	70	71	67	62	54
	C	46	57	61	66	67	63	58	50
	D	41	52	56	61	62	58	53	45
Wylot	A	48	63	66	72	78	74	72	65
	B	46	61	64	70	76	72	70	63
	C	43	58	61	67	73	69	67	60
	D	39	54	57	63	69	65	63	56
Emitowany	A	52	56	58	60	65	65	60	50
	B	50	54	56	58	63	63	58	48
	C	46	50	52	54	59	59	54	44
	D	41	45	47	49	54	54	49	39

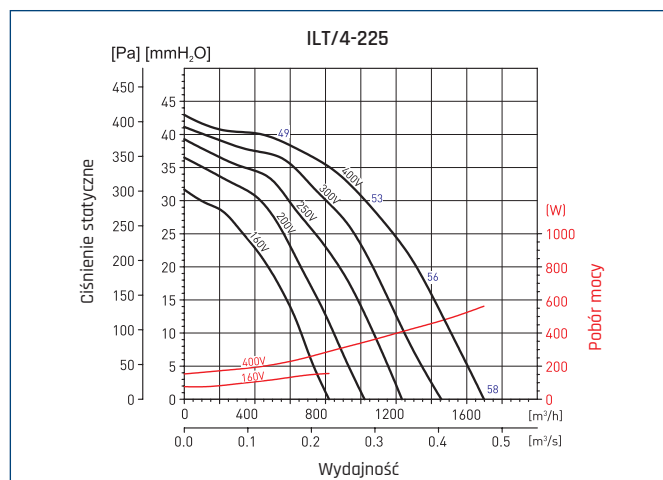

Częstotliwość Hz/dB(A)		63	125	250	500	1000	2000	4000	8000
Wlot	A	52	64	67	72	73	70	65	56
	B	51	63	66	71	72	69	64	55
	C	48	60	63	68	69	66	61	52
	D	44	56	59	64	65	62	57	48
Wylot	A	48	63	66	72	77	74	72	65
	B	48	63	66	72	77	74	72	65
	C	45	60	63	69	74	71	69	62
	D	42	57	60	66	71	68	66	59
Emitowany	A	52	57	58	60	63	63	58	48
	B	51	56	57	59	62	62	57	47
	C	48	53	54	56	59	59	54	44
	D	44	49	50	52	55	55	50	40

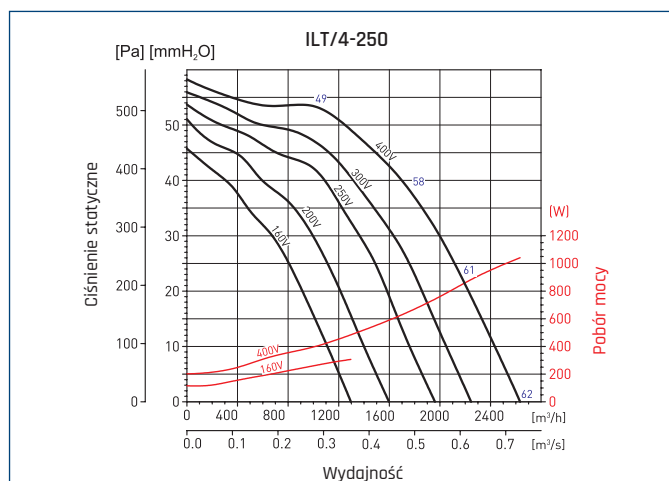

Częstotliwość Hz/dB(A)		63	125	250	500	1000	2000	4000	8000
Wlot	A	58	70	72	77	78	77	72	63
	B	57	69	71	76	77	76	71	62
	C	54	66	68	73	74	73	68	59
	D	49	61	63	68	69	68	63	54
Wylot	A	54	69	71	79	82	81	78	71
	B	53	68	70	78	81	80	77	70
	C	51	66	68	76	79	78	75	68
	D	47	62	64	72	75	74	71	64
Emitowany	A	58	63	63	66	67	66	62	53
	B	57	62	62	65	66	65	61	52
	C	54	59	59	62	63	62	58	49
	D	49	54	54	57	58	57	53	44

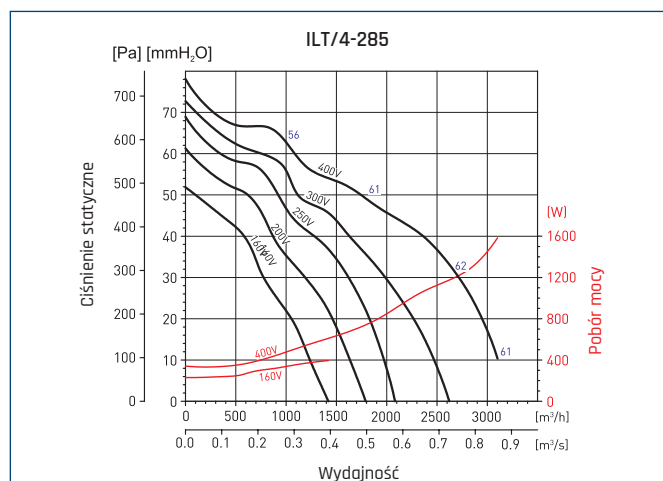

Częstotliwość Hz/dB(A)		63	125	250	500	1000	2000	4000	8000
Wlot	A	58	70	72	76	77	77	73	68
	B	59	71	73	77	78	78	74	69
	C	58	70	72	76	77	77	73	68
	D	54	66	68	72	73	73	69	64
Wylot	A	54	69	71	80	82	81	78	71
	B	56	71	73	82	84	83	80	73
	C	55	70	72	81	83	82	79	72
	D	51	66	68	77	79	78	75	68
Emitowany	A	58	65	65	66	62	62	60	57
	B	59	66	66	67	63	63	61	58
	C	58	65	65	66	62	62	60	57
	D	53	60	60	61	57	57	55	52

## CHARAKTERYSTYKI PRACY I CHARAKTERYSTYKI AKUSTYCZNE

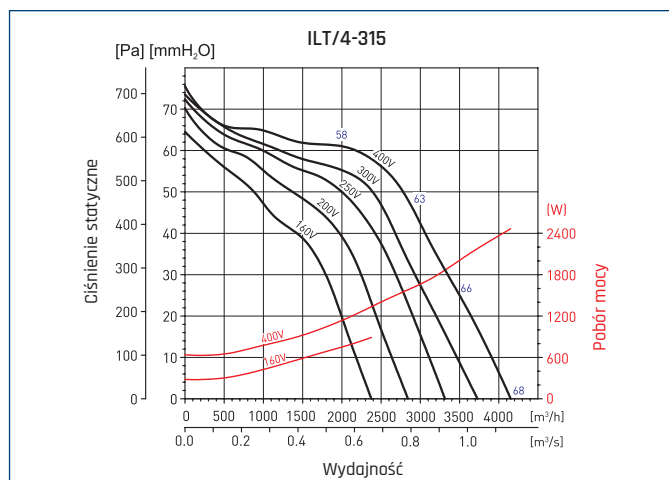

Częstotliwość Hz/dB(A)		63	125	250	500	1000	2000	4000	8000
Wlot	A	65	77	79	83	84	84	80	75
	B	63	75	77	81	82	82	78	73
	C	60	72	74	78	79	79	75	70
	D	54	66	68	72	73	73	69	64
Wylot	A	61	76	78	87	89	88	85	78
	B	60	75	77	86	88	87	84	77
	C	57	72	74	83	85	84	81	74
	D	52	67	69	78	80	79	76	69
Emitowany	A	65	72	72	73	69	69	67	64
	B	63	70	70	71	67	67	65	62
	C	60	67	67	68	64	64	62	59
	D	55	62	62	63	59	59	57	54

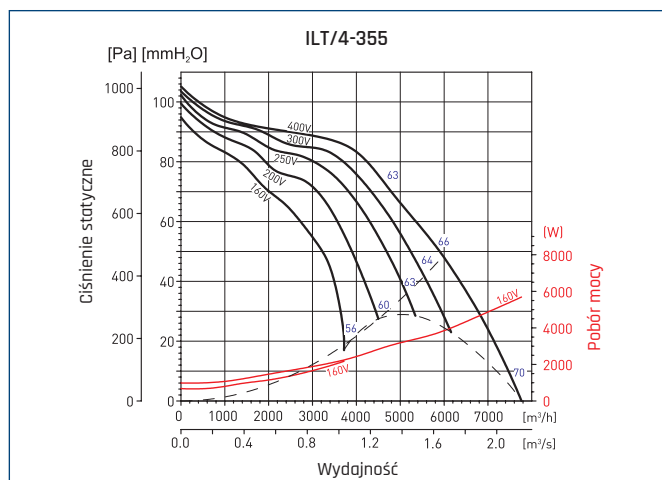

Częstotliwość Hz/dB(A)		63	125	250	500	1000	2000	4000	8000
Wlot	A	66	78	83	86	89	90	87	83
	B	65	77	80	82	85	85	83	79
	C	64	77	75	78	81	80	78	73
	D	65	77	79	81	84	84	82	78
Wylot	A	71	79	85	90	94	93	90	85
	B	67	78	81	86	91	89	86	81
	C	62	75	75	81	86	83	81	74
	D	66	77	80	85	90	88	85	80
Emitowany	A	66	71	71	72	74	76	73	68
	B	65	70	68	68	70	71	69	64
	C	64	70	63	64	66	66	64	58
	D	65	70	67	67	69	70	68	63

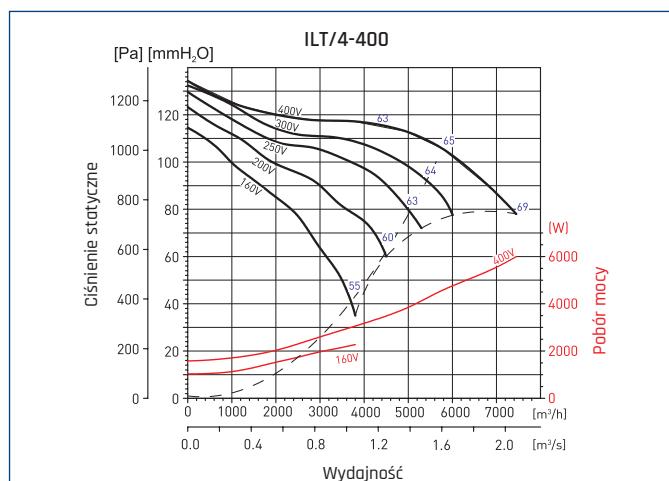

Częstotliwość Hz/dB(A)		63	125	250	500	1000	2000	4000	8000
Wlot	A	68	78	80	82	89	88	85	80
	B	67	77	77	79	86	84	81	76
	C	64	74	75	77	84	82	79	74
Wylot	A	78	82	85	89	93	91	87	82
	B	72	78	80	85	90	87	83	77
	C	71	76	78	83	87	85	81	75
Emitowany	A	63	68	68	71	74	73	70	70
	B	62	67	65	68	71	69	66	66
	C	58	63	62	65	68	67	64	64

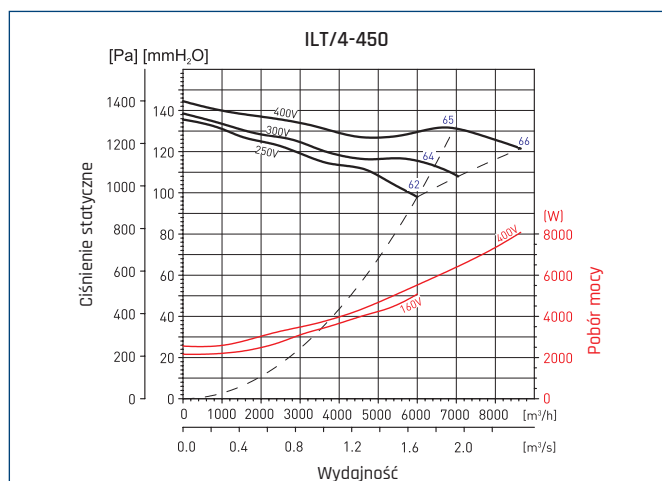

Częstotliwość Hz/dB(A)		63	125	250	500	1000	2000	4000	8000
Wlot	A	78	77	80	81	88	86	82	77
	B	78	77	78	80	87	85	81	76
	C	77	80	84	89	94	93	87	81
Wylot	D	76	79	83	88	93	92	86	80
	Emitowany	A	70	68	67	62	71	69	64
B		70	68	65	61	70	68	63	59

## CHARAKTERYSTYKI PRACY I CHARAKTERYSTYKI AKUSTYCZNE

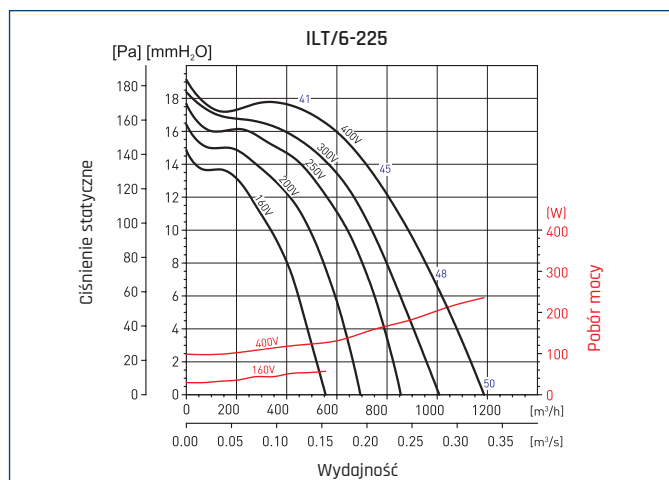

Częstotliwość Hz/dB(A)		63	125	250	500	1000	2000	4000	8000
Wlot	A	48	56	59	64	65	62	57	45
	B	46	54	57	62	63	60	55	43
	C	44	52	55	60	61	56	53	41
	D	39	47	50	55	56	53	48	36
Wylot	A	41	54	57	63	68	65	63	54
	B	40	53	56	62	67	64	62	53
	C	38	51	54	60	65	62	60	51
	D	34	47	50	56	61	58	56	47
Emitowany	A	48	49	50	52	55	55	50	37
	B	46	47	48	50	53	53	48	35
	C	43	44	45	47	50	50	45	32
	D	39	40	41	43	46	46	41	28

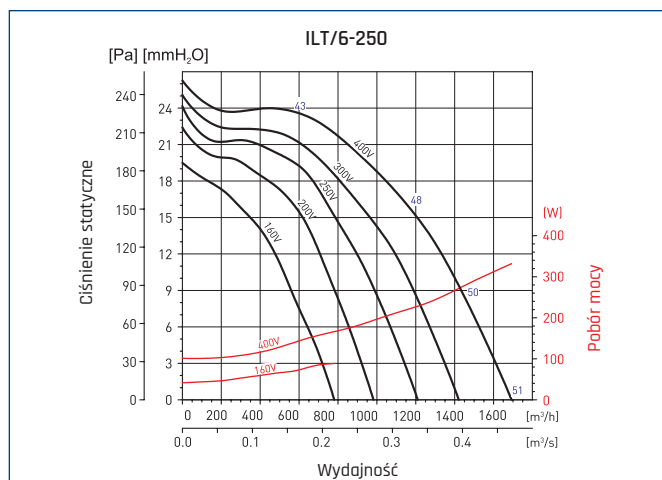

Częstotliwość Hz/dB(A)		63	125	250	500	1000	2000	4000	8000
Wlot	A	51	59	61	66	67	66	61	49
	B	50	58	60	65	66	65	60	48
	C	47	55	57	62	63	62	57	45
	D	43	51	53	58	59	58	53	41
Wylot	A	44	57	59	67	70	69	66	57
	B	44	57	59	67	70	69	66	57
	C	42	55	57	65	68	67	64	55
	D	38	51	53	61	64	63	60	51
Emitowany	A	51	52	52	55	55	55	51	39
	B	50	51	51	54	54	54	50	38
	C	48	49	49	52	52	52	48	36
	D	43	44	44	47	47	47	43	31

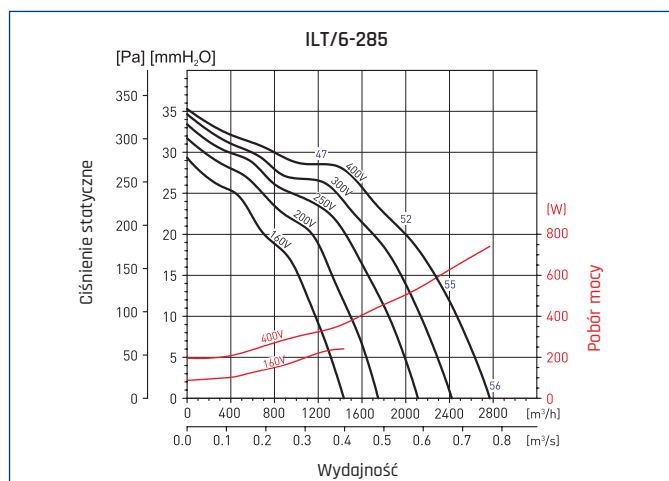

Częstotliwość Hz/dB(A)		63	125	250	500	1000	2000	4000	8000
Wlot	A	55	66	67	71	72	72	68	61
	B	54	64	66	70	71	71	67	60
	C	51	61	63	67	68	68	64	57
	D	45	55	57	61	62	62	58	51
Wylot	A	51	64	66	75	77	76	73	64
	B	51	64	66	75	77	76	73	64
	C	47	60	62	71	73	72	69	60
	D	43	56	58	67	69	68	65	56
Emitowany	A	55	59	60	61	57	57	55	50
	B	54	58	59	60	56	56	54	49
	C	51	56	56	57	53	53	51	46
	D	46	50	51	52	48	48	46	41

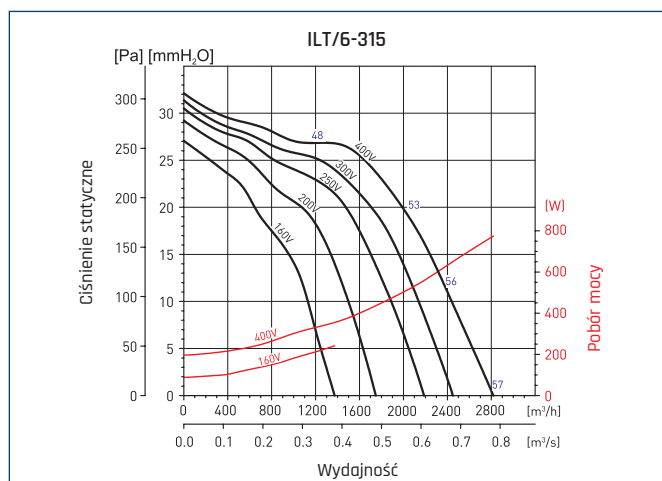

Częstotliwość Hz/dB(A)		63	125	250	500	1000	2000	4000	8000
Wlot	A	55	66	68	72	73	73	69	62
	B	55	65	67	71	72	72	68	61
	C	51	61	63	67	68	68	64	57
	D	46	56	58	62	63	63	59	52
Wylot	A	52	65	67	76	78	77	74	65
	B	51	64	66	75	77	76	73	64
	C	48	61	63	72	74	73	70	61
	D	44	57	59	68	70	69	66	57
Emitowany	A	56	60	61	62	58	58	56	51
	B	55	59	60	61	57	57	55	50
	C	52	56	57	58	54	54	52	47
	D	47	51	52	53	49	49	47	42

## CHARAKTERYSTYKI PRACY I CHARAKTERYSTYKI AKUSTYCZNE

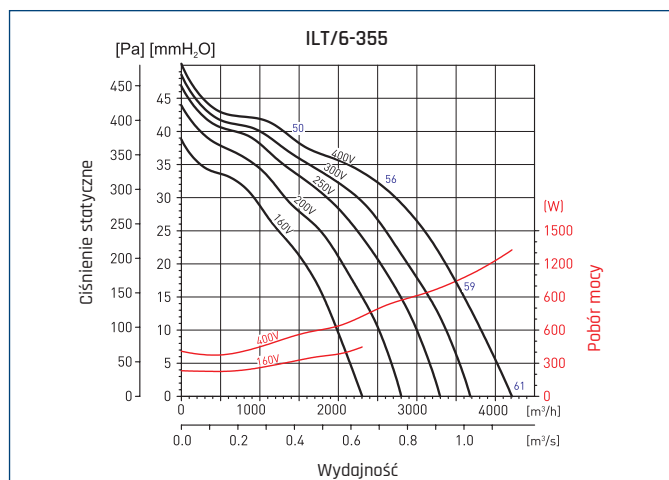

Częstotliwość Hz/dB(A)		63	125	250	500	1000	2000	4000	8000
Wlot	A	61	70	73	77	78	78	74	68
	B	59	68	71	75	76	76	72	66
	C	56	65	68	72	73	73	69	63
	D	50	59	62	66	67	67	63	57
Wylot	A	58	70	73	81	83	82	79	71
	B	57	69	72	80	82	81	78	70
	C	54	66	69	77	79	78	75	67
	D	49	61	64	72	74	73	70	62
Emitowany	A	59	64	66	65	62	61	59	56
	B	57	62	64	63	60	59	57	54
	C	54	59	61	60	57	56	54	51
	D	48	53	55	54	51	50	48	45

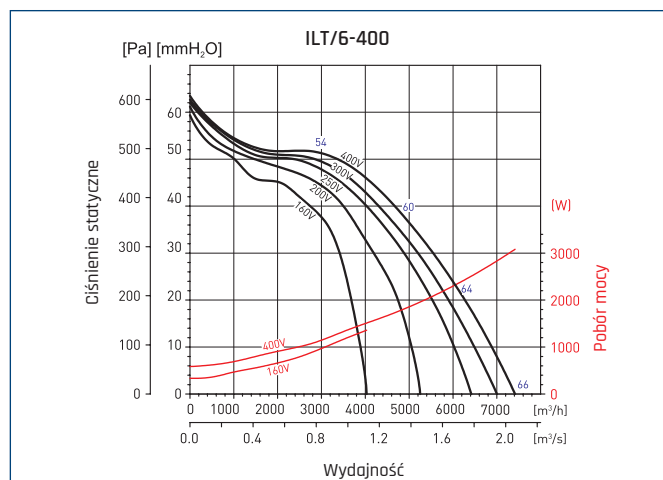

Częstotliwość Hz/dB(A)		63	125	250	500	1000	2000	4000	8000
Wlot	A	70	75	79	83	86	85	81	75
	B	68	73	77	81	84	83	79	73
	C	64	69	73	77	80	79	75	69
	D	58	63	67	71	74	73	69	63
Wylot	A	69	76	81	89	90	89	85	77
	B	68	75	80	87	89	88	84	76
	C	64	71	76	83	85	84	80	72
	D	59	66	71	78	80	79	75	67
Emitowany	A	66	68	70	71	69	67	64	62
	B	64	66	68	69	67	65	62	60
	C	64	66	68	69	67	65	62	60
	D	54	56	58	59	57	55	52	50

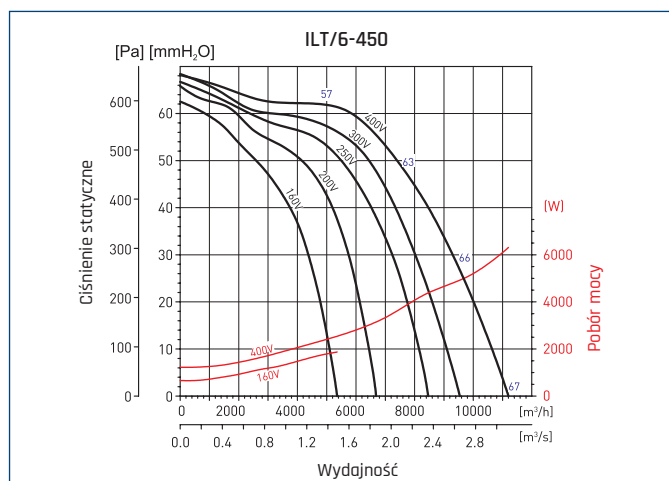

Częstotliwość Hz/dB(A)		63	125	250	500	1000	2000	4000	8000
Wlot	A	74	76	81	85	88	87	83	77
	B	73	75	80	84	87	86	82	76
	C	70	72	77	81	84	83	79	73
	D	64	66	71	75	78	77	73	67
Wylot	A	75	79	85	91	93	92	87	80
	B	74	78	84	90	92	91	86	79
	C	71	75	81	87	89	88	83	76
	D	66	70	76	82	84	83	78	71
Emitowany	A	69	69	72	73	70	67	65	63
	B	67	68	71	72	69	66	64	62
	C	64	65	68	69	66	63	61	59
	D	59	59	62	63	60	57	55	53

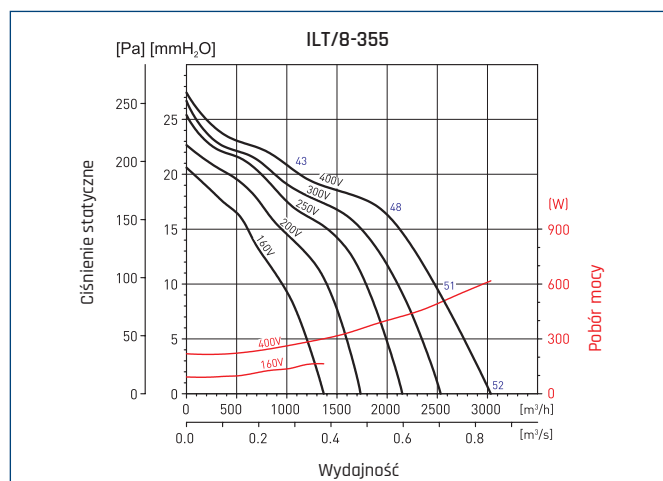

Częstotliwość Hz/dB(A)		63	125	250	500	1000	2000	4000	8000
Wlot	A	54	61	64	68	69	69	65	56
	B	53	60	63	67	68	68	64	55
	C	50	57	60	64	65	65	61	52
	D	45	52	55	59	60	60	56	47
Wylot	A	50	61	64	72	74	73	70	60
	B	50	61	64	72	74	73	70	60
	C	47	58	61	69	71	70	67	57
	D	42	53	56	64	66	65	62	52
Emitowany	A	52	54	57	56	53	52	50	44
	B	51	53	56	55	52	51	49	43
	C	48	50	53	52	49	48	46	40
	D	43	45	48	47	44	43	41	35



## CHARAKTERYSTYKI PRACY I CHARAKTERYSTYKI AKUSTYCZNE

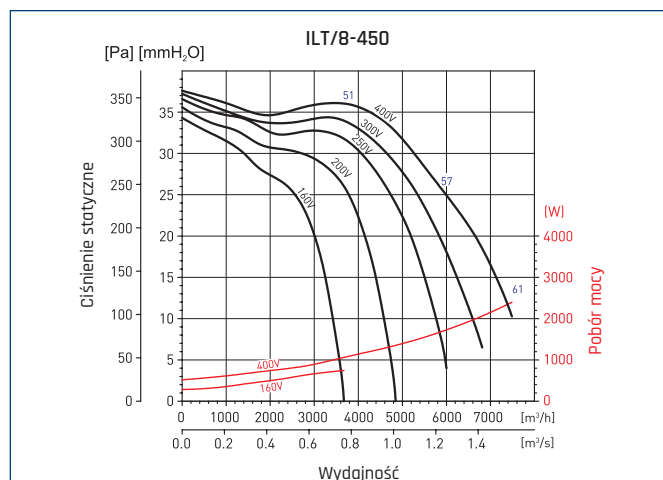
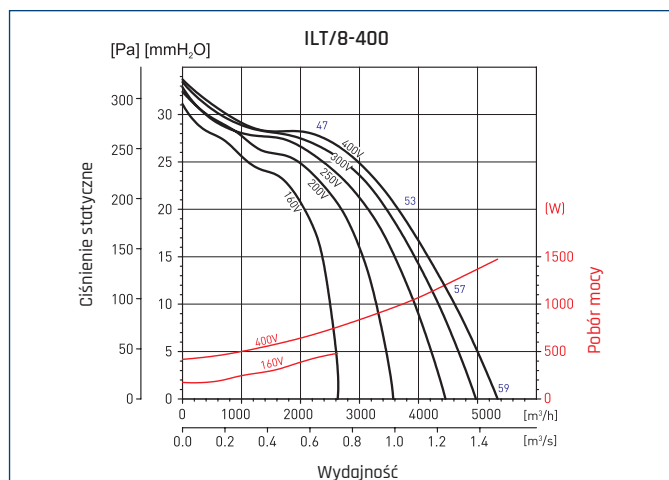

Częstotliwość Hz/dB(A)		63	125	250	500	1000	2000	4000	8000
Wlot	A	64	67	71	75	78	77	73	64
	B	62	65	69	73	76	75	71	62
	C	50	57	60	64	65	65	61	52
	D	53	56	60	64	67	66	62	53
Wylot	A	63	69	74	81	83	82	78	69
	B	61	67	72	79	81	80	76	67
	C	59	64	69	76	78	77	73	64
	D	52	58	63	70	72	71	67	58
Emitowany	A	61	61	63	64	62	60	57	52
	B	59	59	61	62	60	58	55	50
	C	55	55	57	58	56	54	51	46
	D	49	49	51	52	50	48	45	40

Częstotliwość Hz/dB(A)		63	125	250	500	1000	2000	4000	8000
Wlot	A	70	71	75	79	82	81	77	68
	B	68	69	73	77	80	79	75	66
	C	65	66	70	74	77	76	72	63
	D	59	60	64	68	71	70	66	57
Wylot	A	69	72	78	84	86	85	80	72
	B	69	72	78	84	86	85	80	72
	C	65	68	74	80	82	81	76	68
	D	59	62	68	74	76	75	70	62
Emitowany	A	64	64	66	66	64	61	59	54
	B	63	63	65	65	63	60	58	53
	C	59	59	61	61	59	56	54	49
	D	53	53	55	55	53	50	48	43

## WYMIARY [mm]

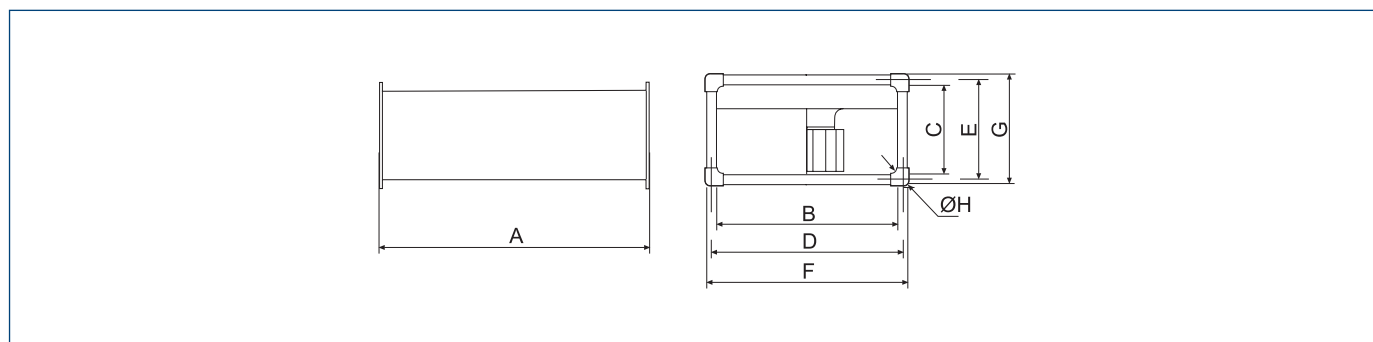

Typ	A	B	C	D	E	F	G	ØH
200	505	400	198	420	220	440	240	9
225	535	500	248	520	270	540	290	9
250	565	500	298	520	320	540	340	9
285	645	600	298	620	320	640	340	9
315	725	600	348	620	370	640	390	9
355	785	700	398	720	420	740	440	9
400	885	800	498	820	520	840	540	9
450	985	1000	498	1020	520	1040	540	9

## AKCESORIA MONTAŻOWE

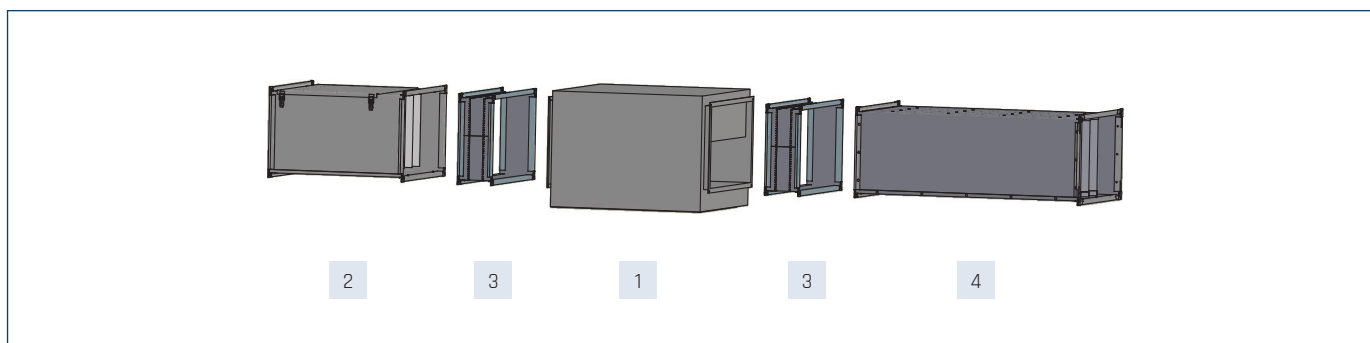

1	2			3	4	
Wentylator	filtr kanałowy DFR			złącze przeciwdrganiewe IAE-PL	tłumik akustyczny RCS	
		wkład filtracyjny do DFR				
		EU3	EU5	EU7		
ILB/4-200	DFR-40/20	EU3   40/20cm	EU5   40/20cm	EU7   40/20cm	IAE-PL-200	RCS-40/20
ILT/4-200	DFR-40/20	EU3   40/20cm	EU5   40/20cm	EU7   40/20cm	IAE-PL-200	RCS-40/20
ILB/4-225	DFR-50/25	EU3   50/25cm	EU5   50/25cm	EU7   50/25cm	IAE-PL-225	RCS-50/25
ILB/6-225	DFR-50/25	EU3   50/25cm	EU5   50/25cm	EU7   50/25cm	IAE-PL-225	RCS-50/25
ILT/4-225	DFR-50/25	EU3   50/25cm	EU5   50/25cm	EU7   50/25cm	IAE-PL-225	RCS-50/25
ILT/6-225	DFR-50/25	EU3   50/25cm	EU5   50/25cm	EU7   50/25cm	IAE-PL-225	RCS-50/25
ILB/4-250	DFR-50/30	EU3   50/30cm	EU5   50/30cm	EU7   50/30cm	IAE-PL-250	RCS-50/30
ILB/6-250	DFR-50/30	EU3   50/30cm	EU5   50/30cm	EU7   50/30cm	IAE-PL-250	RCS-50/30
ILT/4-250	DFR-50/30	EU3   50/30cm	EU5   50/30cm	EU7   50/30cm	IAE-PL-250	RCS-50/30
ILT/6-250	DFR-50/30	EU3   50/30cm	EU5   50/30cm	EU7   50/30cm	IAE-PL-250	RCS-50/30
ILB/6-285	DFR-60/30	EU3   60/35cm	EU5   60/35cm	EU7   60/35cm	IAE-PL-285	RCS-60/30
ILT/4-285	DFR-60/30	EU3   60/35cm	EU5   60/35cm	EU7   60/35cm	IAE-PL-285	RCS-60/30
ILT/6-285	DFR-60/30	EU3   60/35cm	EU5   60/35cm	EU7   60/35cm	IAE-PL-285	RCS-60/30
ILB/6-315	DFR-60/35	EU3   60/35cm	EU5   60/35cm	EU7   60/35cm	IAE-PL-315	RCS-60/35
ILT/4-315	DFR-60/35	EU3   60/35cm	EU5   60/35cm	EU7   60/35cm	IAE-PL-315	RCS-60/35
ILT/6-315	DFR-60/35	EU3   60/35cm	EU5   60/35cm	EU7   60/35cm	IAE-PL-315	RCS-60/35
ILB/6-355	DFR-70/40	EU3   70/40cm	EU5   70/40cm	EU7   70/40cm	IAE-PL-355	RCS-70/40
ILT/4-355	DFR-70/40	EU3   70/40cm	EU5   70/40cm	EU7   70/40cm	IAE-PL-355	RCS-70/40
ILT/6-355	DFR-70/40	EU3   70/40cm	EU5   70/40cm	EU7   70/40cm	IAE-PL-355	RCS-70/40
ILT/8-355	DFR-70/40	EU3   70/40cm	EU5   70/40cm	EU7   70/40cm	IAE-PL-355	RCS-70/40
ILT/4-400	DFR-80/50	EU3   80/50cm	EU5   80/50cm	EU7   80/50cm	IAE-PL-400	RCS-80/50
ILT/6-400	DFR-80/50	EU3   80/50cm	EU5   80/50cm	EU7   80/50cm	IAE-PL-400	RCS-80/50
ILT/8-400	DFR-80/50	EU3   80/50cm	EU5   80/50cm	EU7   80/50cm	IAE-PL-400	RCS-80/50
ILT/4-450	DFR-100/50	EU3   100/50cm	EU5   100/50cm	EU7   100/50cm	IAE-PL-450	RCS-100/50
ILT/6-450	DFR-100/50	EU3   100/50cm	EU5   100/50cm	EU7   100/50cm	IAE-PL-450	RCS-100/50
ILT/8-450	DFR-100/50	EU3   100/50cm	EU5   100/50cm	EU7   100/50cm	IAE-PL-450	RCS-100/50

### Numery artykułów

DFR-100/50	40520990	EU3   40/20cm	40520923	EU5   50/30cm	40520945	EU7   70/40cm	40520977	IAE-PL-450	40532880
DFR-40/20	40520920	EU3   50/25cm	40520933	EU5   60/35cm	40520965	EU7   80/50cm	40520987	RCS-100/50	40521980
DFR-50/25	40520930	EU3   50/30cm	40520943	EU5   70/40cm	40520975	IAE-PL-200	40532810	RCS-40/20	40521910
DFR-50/30	40520940	EU3   60/35cm	40520963	EU5   80/50cm	40520985	IAE-PL-225	40532820	RCS-50/25	40521920
DFR-60/30	40520950	EU3   70/40cm	40520973	EU7   100/50cm	40520997	IAE-PL-250	40532830	RCS-50/30	40521930
DFR-60/35	40520960	EU3   80/50cm	40520983	EU7   40/20cm	40520927	IAE-PL-285	40532840	RCS-60/30	40521940
DFR-70/40	40520970	EU5   100/50cm	40520995	EU7   50/25cm	40520937	IAE-PL-315	40532850	RCS-60/35	40521950
DFR-80/50	40520980	EU5   40/20cm	40520925	EU7   50/30cm	40520947	IAE-PL-355	40532860	RCS-70/40	40521960
EU3   100/50cm	40520993	EU5   50/25cm	40520935	EU7   60/35cm	40520967	IAE-PL-400	40532870	RCS-80/50	40521970



## AKCESORIA ELEKTRYCZNE

Wentylator	termostat ścienny	termostat kanałowy	czujnik zanieczyszczeń	higrostat	regulator tyrystorowy		
	TS	TK-1			SQA	HIG-2	REB N
ILB/4-200	TS	TK-1	SQA	HIG-2	REB-2.5 N	REB-2.5 NE	TLR 15 DS
ILB/4-225	TS	TK-1	SQA	HIG-2		REB-5	TLR 25 DS
ILB/6-225	TS	TK-1	SQA	HIG-2	REB-2.5 N	REB-2.5 NE	TLR 15 DS
ILB/4-250	TS	TK-1	SQA + DILM 7-10	HIG-2 + DILM 7-10		REB-5	-
ILB/6-250	TS	TK-1	SQA	HIG-2	REB-2.5 N	REB-2.5 NE	TLR 25 DS
ILB/6-285	TS	TK-1	SQA	HIG-2		REB-5	-
ILB/6-315	TS	TK-1	SQA	HIG-2		REB-5	-
ILB/6-355	TS	TK-1	SQA	HIG-2		REB-10	-

Wentylator	11-stopniowy regulator tyrystorowy	2-nastawowy 6-bieg. regulator tyrystorowy	ERV	regulator transformatorowy		regulator transformatorowy 2-nastawowy	
	IRF	RND-1		RMB	RVS	SC 2	SC 2A
ILB/4-200	IRF-900	RND-1	ERV-3	RMB-1.5	RVS-1.5	SC2-1-15L25	SC2A1-15L25
ILB/4-225	IRF-900	-	ERV-5	RMB-3.5	RVS-3	SC2-1-25L25	SC2A1-25L25
ILB/6-225	IRF-900	RND-1	ERV-3	RMB-1.5	RVS-1.5	SC2-1-15L25	SC2A1-15L25
ILB/4-250	-	-	ERV-10	RMB-8	RVS-5	SC2-1-50L25	SC2A1-50L25
ILB/6-250	IRF-900	RND-1	ERV-3	RMB-3.5	RVS-1.5	SC2-1-15L25	SC2A1-15L25
ILB/6-285	IRF-900	-	ERV-5	RMB-3.5	RVS-5	SC2-1-35L25	SC2A1-35L25
ILB/6-315	IRF-900	-	ERV-5	RMB-3.5	RVS-5	SC2-1-35L25	SC2A1-35L25
ILB/6-355	-	-	ERV-10	RMB-8	RVS-7	SC2-1-75L25	SC2A1-75L25

Wentylator	termostat ścienny	termostat kanałowy	czujnik zanieczyszcz.	higrostat	regulator transform.	regulator transformatorowy 2-nastawowy		falownik
	TS	TK-1				SC 2	SC 2A	
ILT/4-200	TS + DILM 7-10	TK-1 + DILM 7-10	SQA + DILM 7-10	HIG-2 + DILM 7-10	RMT-1.5	SC2-4-15L55	SC2A4-15L55	L 0.4kW
ILT/4-225	TS + DILM 7-10	TK-1 + DILM 7-10	SQA + DILM 7-10	HIG-2 + DILM 7-10	RMT-1.5	SC2-4-15L55	SC2A4-15L55	L 0.4kW
ILT/6-225	TS + DILM 7-10	TK-1 + DILM 7-10	SQA + DILM 7-10	HIG-2 + DILM 7-10	RMT-1.5	SC2-4-15L55	SC2A4-15L55	L 0.4kW
ILT/4-250	TS + DILM 7-10	TK-1 + DILM 7-10	SQA + DILM 7-10	HIG-2 + DILM 7-10	RMT-2.5	SC2-4-25L55	SC2A4-25L55	L 0.75kW
ILT/6-250	TS + DILM 7-10	TK-1 + DILM 7-10	SQA + DILM 7-10	HIG-2 + DILM 7-10	RMT-1.5	SC2-4-15L55	SC2A4-15L55	L 0.4kW
ILT/4-285	TS + DILM 7-10	TK-1 + DILM 7-10	SQA + DILM 7-10	HIG-2 + DILM 7-10	RMT-5	SC2-4-25L55	SC2A4-25L55	L 1.5kW
ILT/6-285	TS + DILM 7-10	TK-1 + DILM 7-10	SQA + DILM 7-10	HIG-2 + DILM 7-10	RMT-1.5	SC2-4-15L55	SC2A4-15L55	L 0.4kW
ILT/4-315	TS + DILM 7-10	TK-1 + DILM 7-10	SQA + DILM 7-10	HIG-2 + DILM 7-10	RMT-5	SC2-4-60L55	SC2A4-60L55	L 2.2kW
ILT/6-315	TS + DILM 7-10	TK-1 + DILM 7-10	SQA + DILM 7-10	HIG-2 + DILM 7-10	RMT-2.5	SC2-4-110L55	SC2A4-110L55	L 0.75kW
ILT/4-355	TS + DILM 12-10	TK-1 + DILM 12-10	SQA + DILM 12-10	HIG-2 + DILM 12-10	RMT-12	SC2-4-110L55	SC2A4-110L55	L 5.5kW
ILT/6-355	TS + DILM 7-10	TK-1 + DILM 7-10	SQA + DILM 7-10	HIG-2 + DILM 7-10	RMT-5	SC2-4-40L55	SC2A4-40L55	L 1.5kW
ILT/8-355	TS + DILM 7-10	TK-1 + DILM 7-10	SQA + DILM 7-10	HIG-2 + DILM 7-10	RMT-2.5	SC2-4-15L55	SC2A4-15L55	L 0.4kW
ILT/4-400	TS + DILM 12-10	TK-1 + DILM 12-10	SQA + DILM 12-10	HIG-2 + DILM 12-10	RMT-12	SC2-4-110L55	SC2A4-110L55	L 7.5kW
ILT/6-400	TS + DILM 7-10	TK-1 + DILM 7-10	SQA + DILM 7-10	HIG-2 + DILM 7-10	RMT-8	SC2-4-80L55	SC2A4-80L55	L 4.0kW
ILT/8-400	TS + DILM 7-10	TK-1 + DILM 7-10	SQA + DILM 7-10	HIG-2 + DILM 7-10	RMT-5	SC2-4-40L55	SC2A4-40L55	L 2.2kW
ILT/4-450	TS + DILM 15-10	TK-1 + DILM 15-10	SQA + DILM 15-10	HIG-2 + DILM 15-10	-	-	-	L 7.5kW
ILT/6-450	TS + DILM 12-10	TK-1 + DILM 12-10	SQA + DILM 12-10	HIG-2 + DILM 12-10	RMT-12	SC2-4-110L55	SC2A4-110L55	L 5.5kW
ILT/8-450	TS + DILM 7-10	TK-1 + DILM 7-10	SQA + DILM 7-10	HIG-2 + DILM 7-10	RMT-8	SC2-4-60L55	SC2A4-60L55	L 4.0kW

## Numery artykułów

DILM 7-10	91040997	L 4.0kW	40016352	RMT-2.5	40025105	SC2-1-75L25	40025258	SC2A4-110L55	40025280
DILM 12-10	91040666-41	L 5.5kW	40016362	RMT-5	40025115	SC2-4-110L55	40025279	SC2A4-15L55	40025270
DILM 15-10	91040666-42	L 7.5kW	40016372	RMT-8	40025120	SC2-4-15L55	40025269	SC2A4-25L55	40025272
ERV-10	40025054	REB-10	40025055	RND-1	40025630	SC2-4-25L55	40025271	SC2A4-40L55	40025274
ERV-3	40025046	REB-2.5 N	40025030	RVS-1.5	40025232	SC2-4-40L55	40025273	SC2A4-60L55	40025276
ERV-5	40025053	REB-2.5 NE	40025040	RVS-3	40025234	SC2-4-60L55	40025275	SC2A4-80L55	40025278
HIG-2	40025150	REB-5	40025051	RVS-5	40025235	SC2-4-80L55	40025277	SQA	40025140
IRF-900	40015154	RMB-1.5	40025060	RVS-7	40025236	SC2A1-15L25	40025251	TK-1	40025330
L 0.4kW	40016302	RMB-3.5	40025070	SC2-1-15L25	40025250	SC2A1-25L25	40025253	TLR 15 DS	40025025
L 0.75kW	40016312	RMB-8	40025080	SC2-1-25L25	40025252	SC2A1-35L25	40025255	TLR 25 DS	40025045
L 1.5kW	40016322	RMT-1.5	40025100	SC2-1-35L25	40025254	SC2A1-50L25	40025257	TS	40025345
L 2.2kW	40016332	RMT-12	40025130	SC2-1-50L25	40025256	SC2A1-75L25	40025259		

## AKCESORIA ELEKTRYCZNE

									
termostat <b>TS</b> str. 650	termostat <b>TK-1</b> str. 650	czujnik <b>SQA</b> str. 645	higrostat <b>HIG-2</b> str. 645	regulator <b>REB</b> str. 638	regulator <b>TLR</b> str. 639	regulator <b>IRF</b> str. 639	regulator <b>RND-1</b> str. 641	regulator <b>ERV</b> str. 642	regulator <b>RMB/RMT</b> str. 640
									
regulator <b>RVS</b> str. 640	transformator 2-nastawowy str. 641	falownik str. 643	stycznik <b>DILM</b>						