

WENTYLATOR PROMIENIOWY WB-K JEDNOBIEGOWY



Wentylator promieniowy WB-K jednobiegowy

Wentylatory promieniowe typu WB przystosowane są do przetłaczania powietrza czystego lub zanieczyszczonego o maksymalnym stężeniu zapylenia do $0,3\text{g}/\text{m}^3$ i temperaturze $+40^\circ\text{C}$. Znajdują zastosowanie w instalacjach wentylacyjnych (nawiewnych lub wywiewnych) w przemyśle, rolnictwie, budownictwie, a także w różnych rodzajach obiektów użyteczności publicznej jak: laboratoria, magazyny, szpitale, szkoły, stołówki, baseny, oczyszczalnie ścieków itp. Wentylatory typu WA wykonane są z twardego PVC

Stopień ochrony: **IP 55**

Klasa izolacji : **F**

Wykonanie:
Standardowe: $+ 40^\circ\text{C}$

Specjalne: $+ 60^\circ\text{C}$

Dostępne kolory: biały i szary

Malowanie osłony silnika na dowolny kolor wg wskaźnika RAL

Dane techniczne

Wielkość wentylatora	Opracowanie	Prędkość obrotowa [obr/min]	Zakres wydajności		Zakres spiętrzenia statycznego [Pa]	Moc silnika [kW]	Poziom dźwięku	
			[m ³ /s]	[m ³ /h]			W odległ. 1m [dB (A)]	W odległ. 5m [dB (A)]
WB 25 - K	I	700	0,065÷0,28	234÷1008	88÷20	0,12	51	51
	II	950	0,085÷0,36	306÷1296	145÷35	0,18	56	56
	III	1450	0,13÷0,56	468÷2016	350÷80	0,25	64	64
WB 30 - K	I	700	0,110÷0,493	396÷1175	135÷38	0,18	53	44
	II	950	0,14÷0,64	504÷2304	225÷59	0,25	57	48
	III	1450	0,22÷0,975	792÷3510	530÷150	0,55	68	59
WB 40 - K	I	700	0,28÷1,143	1008÷4115	225÷54	0,25	61	52
	II	950	0,38÷1,55	1368÷5580	415÷100	0,55	68	59
WB 50 - K	I	700	0,65÷2,6	2340÷9360	435÷115	1,10	69	63
	II	950	0,85÷3,4	3312÷12240	720÷160	2,20	75	66

Charakterystyki

WB 20 - K

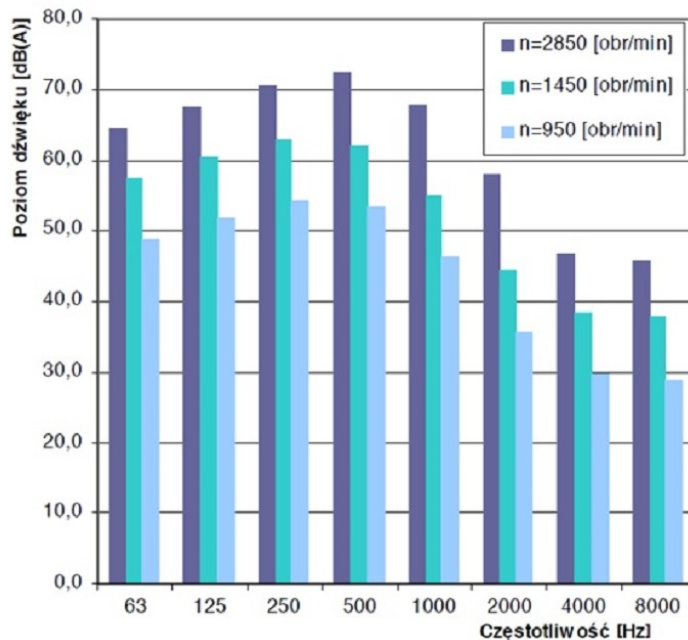
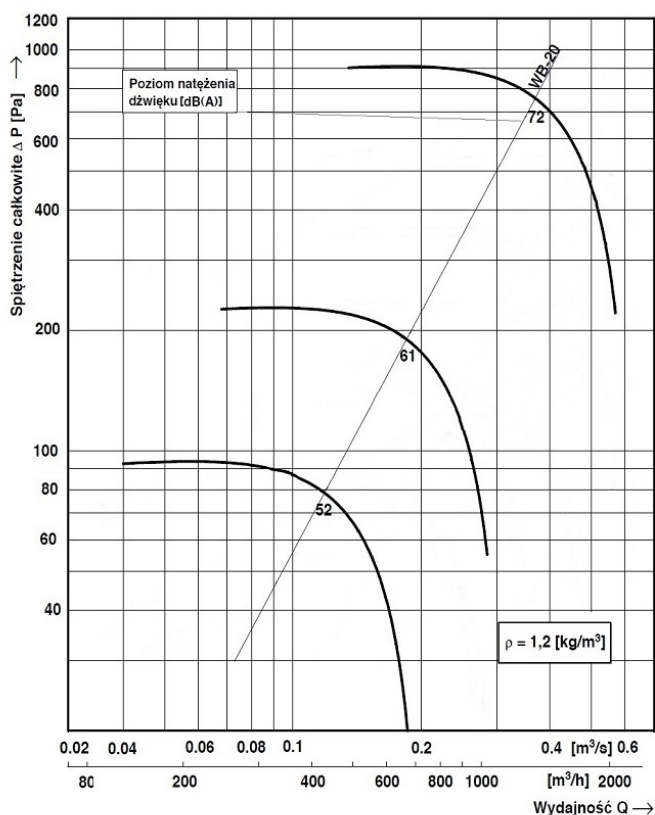

Obroty silnika [obr/min]	Częstotliwość [Hz]								Poziom dźwięku [dB(A)]
	63	125	250	500	1000	2000	4000	8000	
2800	64	67	70	72	68	58	47	46	72
1450	52	55	59	59	49	39	27	19	61
950	46	49	51	46	36	25	19	18	52

WB 25 - K

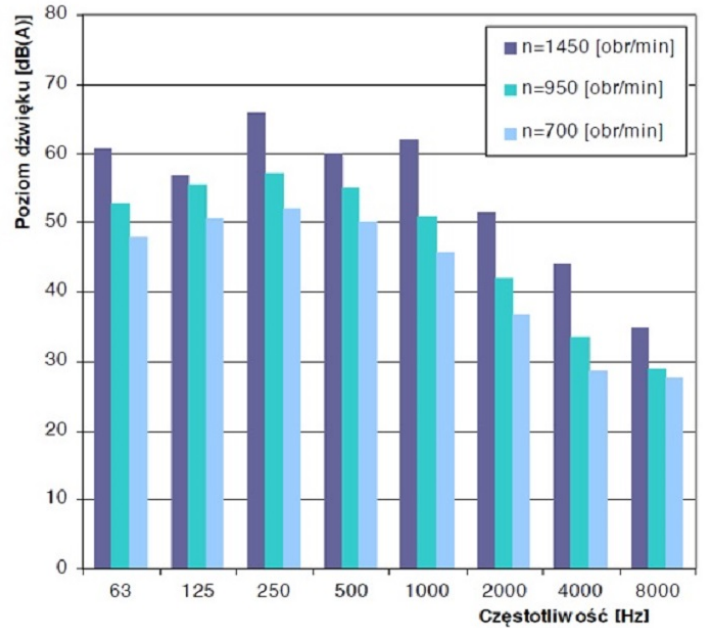
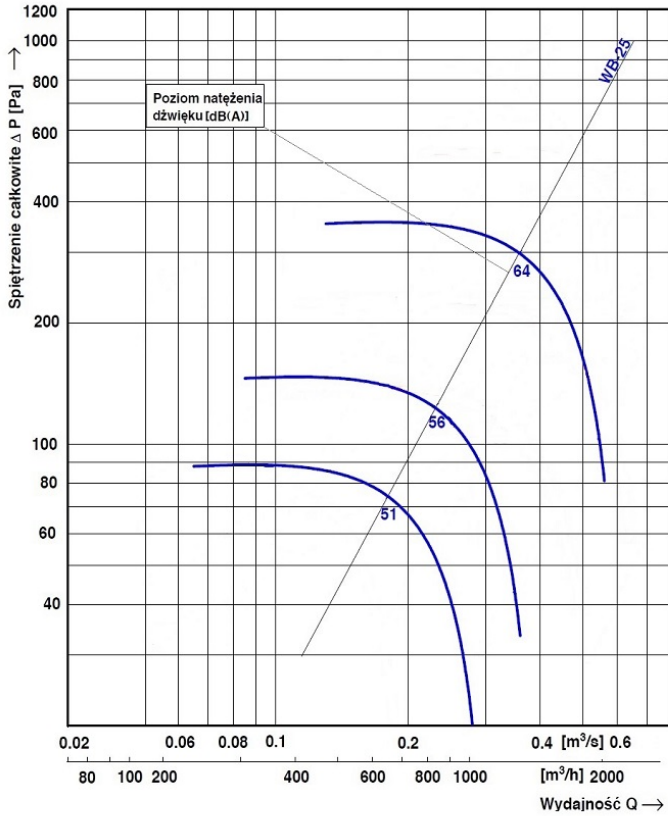

Obroty silnika [obr/min]	Częstotliwość [Hz]								Poziom dźwięku [dB(A)]
	63	125	250	500	1000	2000	4000	8000	
2800	61	57	66	60	62	51	44	35	64
1450	53	56	57	55	51	42	34	29	56
950	48	50	52	50	46	37	29	28	51

WB 30 - K

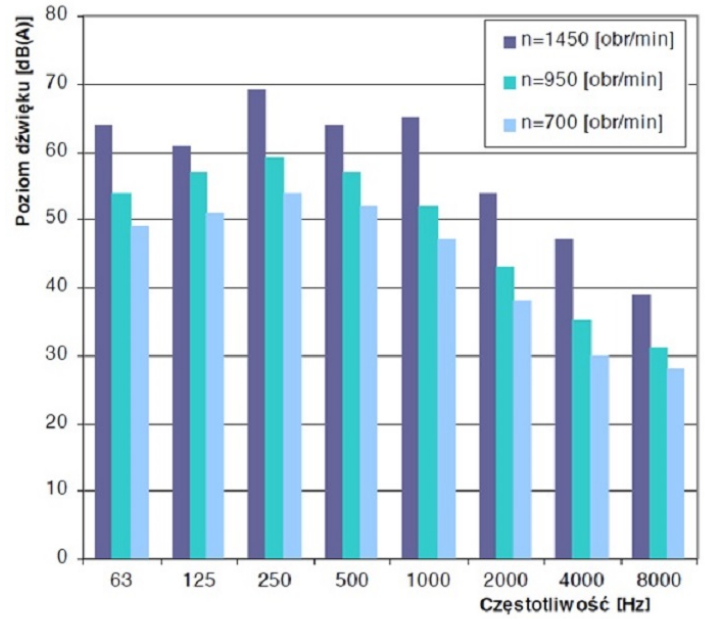
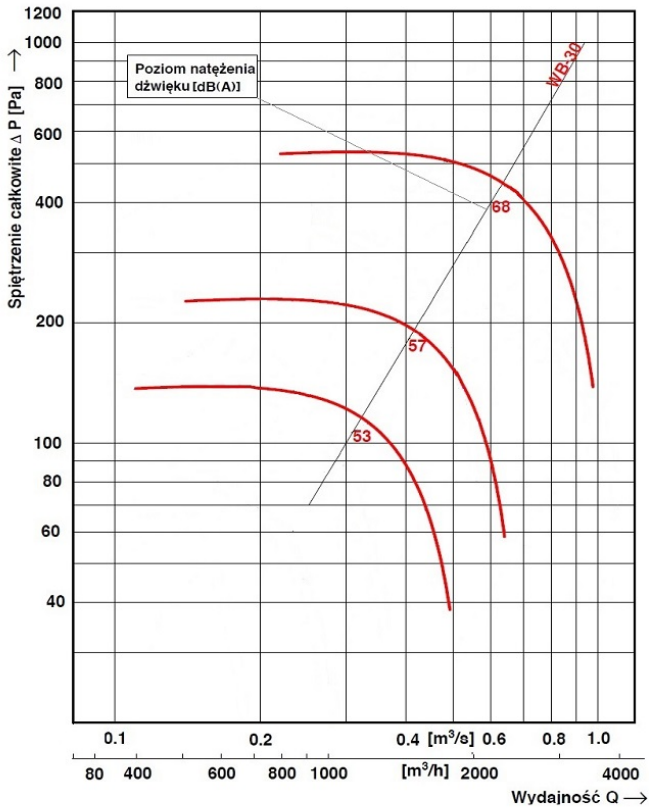

Obroty silnika [obr/min]	Częstotliwość [Hz]								Poziom dźwięku [dB(A)]
	63	125	250	500	1000	2000	4000	8000	
2800	64	60	69	64	65	54	47	39	68
1450	54	57	59	57	52	43	35	31	57
950	49	51	54	52	47	38	30	29	53

WB 40 - K

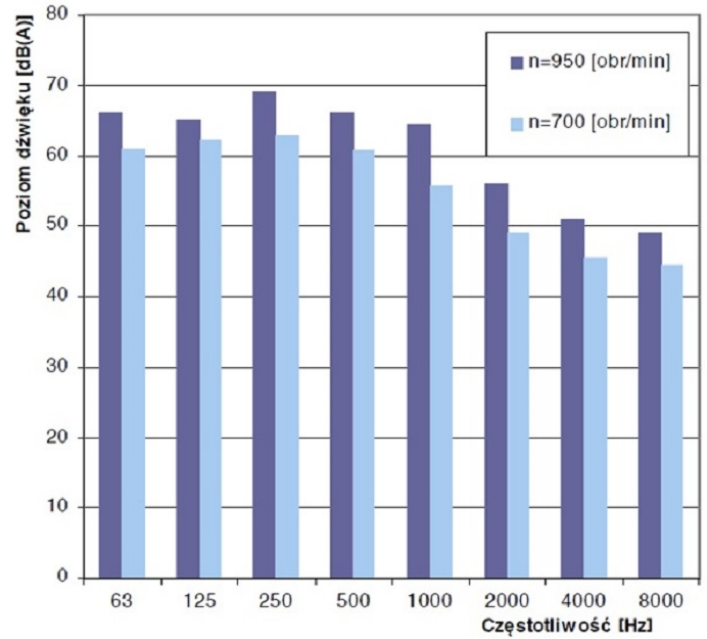
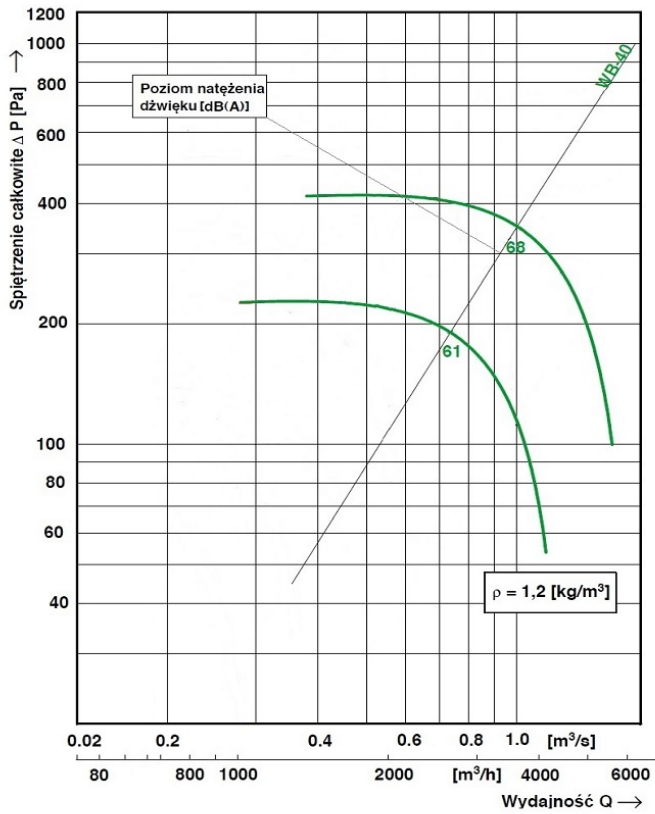

Obroty silnika [obr/min]	Częstotliwość [Hz]								Poziom dźwięku [dB(A)]
	63	125	250	500	1000	2000	4000	8000	
950	66	65	69	66	64,5	56	51	49	68
700	61	62	63	61	56	49	45	44	61

WB 50 - K

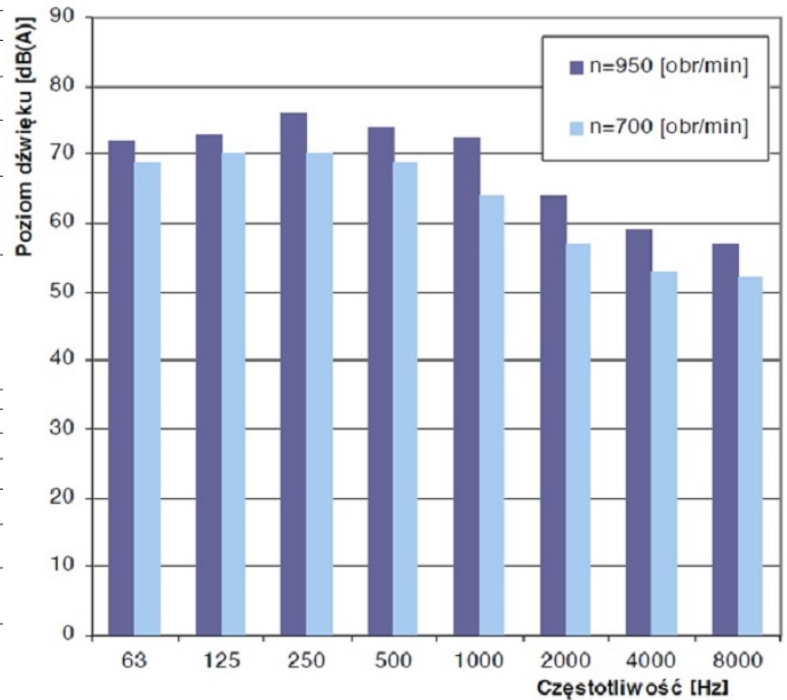
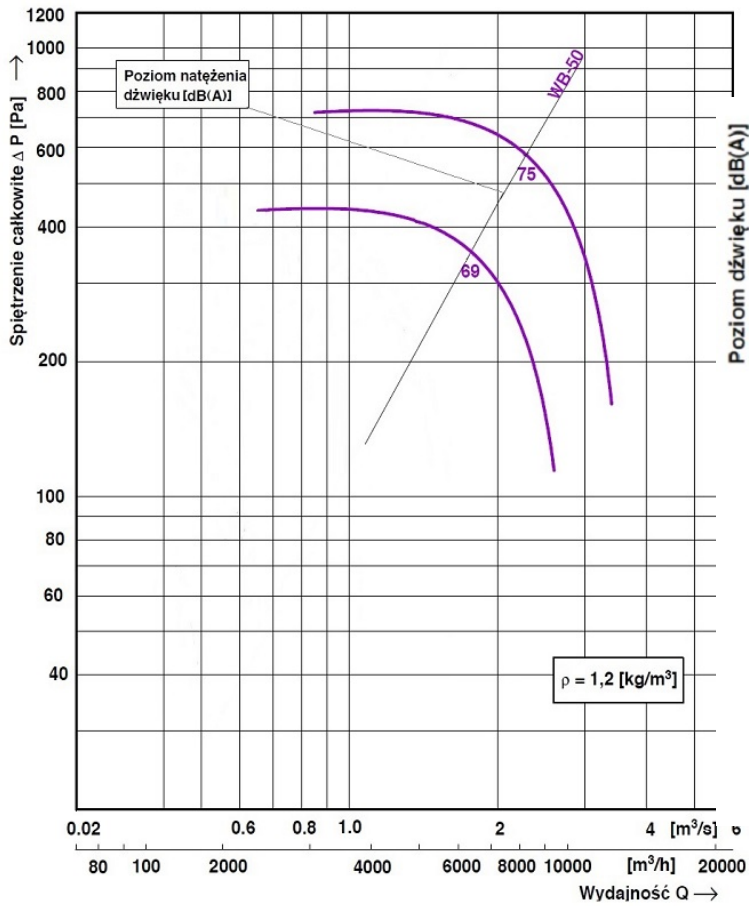

Obroty silnika [obr/min]	Częstotliwość [Hz]								Poziom dźwięku [dB(A)]
	63	125	250	500	1000	2000	4000	8000	
950	72	73	76	74	72,5	64	59	57	75
700	69	70	70	69	64	57	53	52	69

Parametry silników:

Wielkość wentylatora a	Opracowanie	Prędkość obrotowa	Moc silnika	Silnik trójfazowy U=400 [V]		Silnik jednofazowy U=230 [V]	
		[obr/min]	[kW]	Typ silnika	Pobór prądu [A]	Typ silnika	Pobór prądu [A]
WB 20-K	I	950	0,18	Sh 71-6S	0,75	-	-
	II	1450	0,25	Sh 71-4A	0,85	SSh 71-4B	1,70
	III	2850	0,55	Sh 71-2B	1,35	SSh 71-2B	3,40

WB 25-K	I	700	0,12	Sh 71-8B	0,70	-	-
	II	950	0,18	Sh 71-6A	0,75	-	-
	III	1450	0,25	Sh 71-4A	0,85	SSh 71-4B	1,70
WB 30-K	I	700	0,18	Sh 71-8A	0,90	-	-
	II	950	0,25	Sh 71-6B	1,00	-	-
	III	1450	0,55	Sh 80-4A	1,60	SSh 80-4B	3,80
WB 40-K	I	700	0,25	Sh 80-8B	1,20	-	-
	II	950	0,55	Sh 80-4A	1,80	-	-
WB 50-K	I	700	1,10	Sg 100L-8B	3,40	-	-
	II	950	2,20	3SIE 11M-6*	5,10	-	-

*możliwość zastosowania silnika 2SIEK z falownikiem

Wymiary

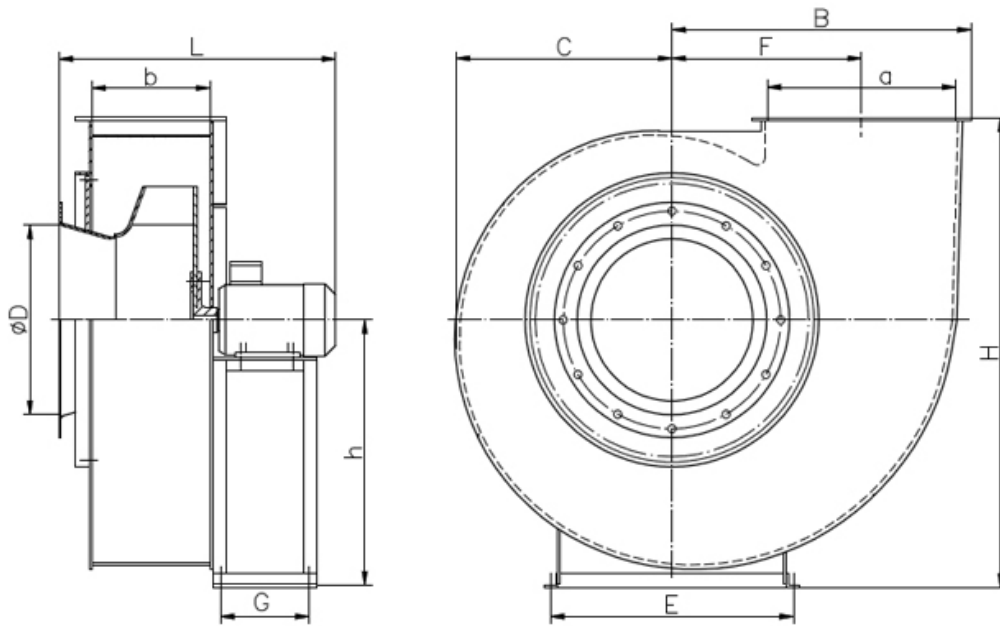

Wymiary

Masa

Wielkość wentylatora

[mm]

[kg]

	D	a	b	H(RD 0)	F	C	G	E	L	H	B	
WB 20 - K	200	237	133	326	224	240	370	278	510	568	381	25
WB 25 - K	250	297	166	398	280	297	405	308	545	698	473	30
WB 30 - K	300	356	199	482	336	358	440	414	620	848	557	39
WB 40 - K	400	474	265	917	447	470	580	514	680	1080	728	60
WB 50 - K	500	500	315	715	500	570	640	640	730	1235	788	107

Układy wylotu:

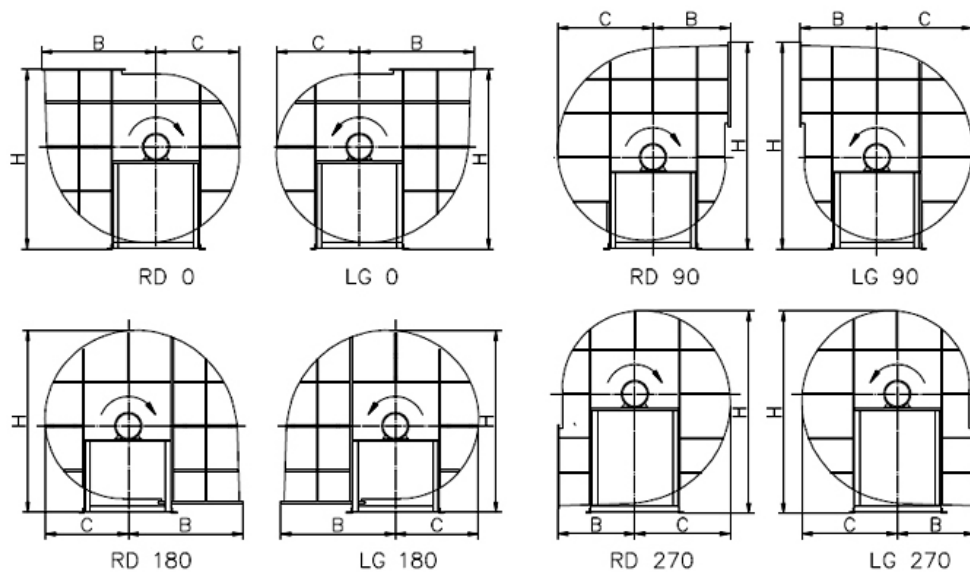

Wielkość wentylatora	Układ	Wymiary [mm]		
		H	B	C
WB 20 - K	RD 0, LG 0	568	381	240
	RD 90, LG 90	659	242	291
	RD 180, LG 180	550	381	240
	RD 270, LG 270	629	242	291
WB 25 - K	RD 0, LG 0	698	473	297
	RD 90, LG 90	805	300	363
	RD 180, LG 180	675	473	297
	RD 270, LG 270	784	300	363
WB 30 - K	RD 0, LG 0	848	557	358
	RD 90, LG 90	960	336	437
	RD 180, LG 180	809	557	358
	RD 270, LG 270	930	336	437
WB 40 - K	RD 0, LG 0	1080	728	470
	RD 90, LG 90	1240	433	612
	RD 180, LG 180	1094	728	470
	RD 270, LG 270	1213	433	612
WB 50 - K	RD 0, LG 0	1235	788	570
	RD 90, LG 90	1380	535	650
	RD 180, LG 180	1235	570	765
	RD 270, LG 270	1380	780	572